



Grayhill, Inc.

62S11-M0-020SH

Številka dela:

62S11-M0-020SH

Proizvajalec / znamka:

Grayhill, Inc.

Opis izdelka

ROTARY ENCODER OPT 32PPR 2" CBL

Podatkovni listi:

 62S11-M0-020SH.pdf

Status RoHS

 Skladen brez svinca / RoHS

Stanje zalog

2051 pcs stock

Iz ladje

Hong Kong

Način pošiljanja

DHL/Fedex/TNT/UPS/EMS

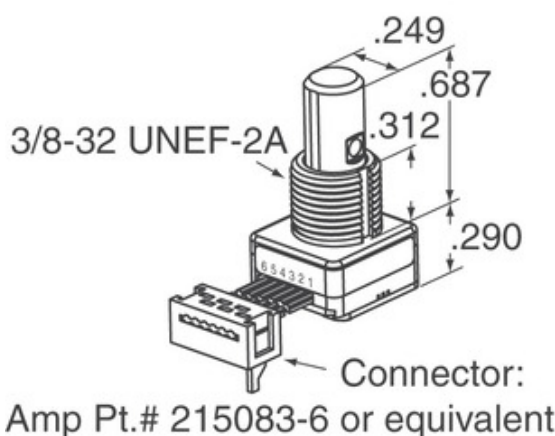

Slika je lahko reprezentativna. Oglejte si specifikacije za podrobnosti izdelka.

[ZAHTEVA ZA PONUDBO](#)







Specifikacije 62S11-M0-020SH

ŠTEVILKA DELA	62S11-M0-020SH
PROIZVAJALEC	Grayhill, Inc.
OPIS	ROTARY ENCODER OPT 32PPR 2" CBL
STATUS SVOBODNEGA STATUSA / ROHS	Skladen brez svinca / RoHS
KOLIČINA NA VOLJO	2051 pcs
PODATKOVNI LIST	 62S11-M0-020SH.pdf
NAPETOST - OSKRBA	5V
SKLOP ZAKLJUČKA	Cable Leads
SERIJA	62S
ROTACIJSKO ŽIVLJENJE (CIKLI MIN)	1M
STIKI NA REVOLUCIJO	32
VRSTA IZHODA	Quadrature (Incremental)
USMERJENOST	Vertical
TIP MONTAŽE	Panel Mount
RAVEN OBČUTLJIVOSTI NA VLAGO (MSL)	1 (Unlimited)
STATUS SVOBODNEGA STATUSA / ROHS	Lead free / RoHS Compliant
TIP DAJALNIKA	Optical
PRIDRŽANJE	Yes
VGRAJEN STIKALO	No
TIP AKTUATORJA	1/4" Dia Flatted End

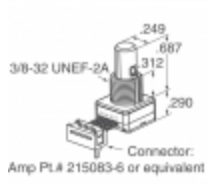
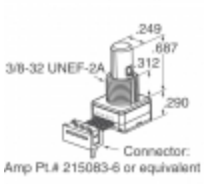
Sorodne oznake

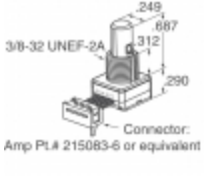
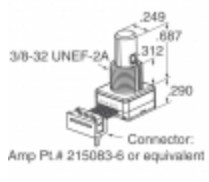
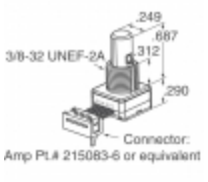
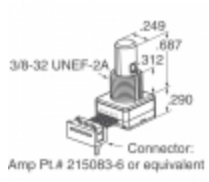
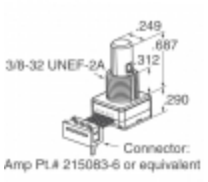
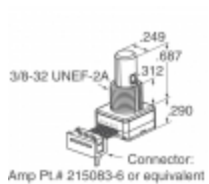
Grayhill, Inc. 62S11-M0-020SH	62S11-M0-020SH Distributer	62S11-M0-020SH Dobavitelj
Cena 62S11-M0-020SH	Slike 62S11-M0-020SH	Slika 62S11-M0-020SH
62S11-M0-020SH PDF Datasheet	62S11-M0-020SH Prenesi podatkovni list	62S11-M0-020SH Datasheet
Zaloga 62S11-M0-020SH	Kupi 62S11-M0-020SH	Kupi Grayhill, Inc. 62S11-M0-020SH
Grayhill, Inc. 62S11-M0-020SH	Grayhill, Inc. Dobavitelj	Distributer Grayhill, Inc.
Grayhill, Inc. 62S11-M0-020SH	Grayhill Inc. 62S11-M0-020SH	

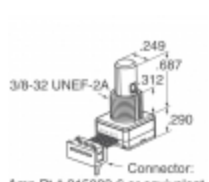
Podobni izdelki

 <p>62S11-M0-030CH Proizvajalci: Grayhill, Inc. Opis: ROTARY ENCODER OPTICAL 32PPR Na zalogi: 2151 pcs</p> <p>RFQ</p>	 <p>62S11-M0-060CH Proizvajalci: Grayhill, Inc. Opis: ROTARY ENCODER OPTICAL 32PPR Na zalogi: 1968 pcs</p> <p>RFQ</p>
 <p>62S11-M0-040CH Proizvajalci: Grayhill, Inc. Opis: ROTARY ENCODER OPT 32PPR 2" CBL Na zalogi: 1915 pcs</p> <p>RFQ</p>	 <p>62S11-L9-020CH Proizvajalci: Grayhill, Inc. Opis: ROTARY ENCODER OPTICAL 32PPR Na zalogi: 2264 pcs</p> <p>RFQ</p>
 <p>62S11-M0-020C Proizvajalci: Grayhill, Inc. Opis: ROTARY ENCODER OPT 32PPR 2" CBL Na zalogi: 1812 pcs</p> <p>RFQ</p>	 <p>62S11-L9-040C Proizvajalci: Grayhill, Inc. Opis: ROTARY ENCODER OPTICAL 32PPR Na zalogi: 1938 pcs</p> <p>RFQ</p>
 <p>62S11-L9-020S Proizvajalci: Grayhill, Inc. Opis: ROTARY ENCODER OPTICAL 32PPR Na zalogi: 2134 pcs</p> <p>RFQ</p>	 <p>62S11-L9-PH Proizvajalci: Grayhill, Inc. Opis: ROTARY ENCODER OPTICAL 32PPR Na zalogi: 1972 pcs</p> <p>RFQ</p>
 <p>62S11-M0-200S Proizvajalci: Grayhill, Inc. Opis: ROTARY ENCODER OPTICAL 32PPR Na zalogi: 2199 pcs</p> <p>RFQ</p>	 <p>62S11-M0-060C Proizvajalci: Grayhill, Inc. Opis: ROTARY ENCODER OPT 32PPR 6" CBL Na zalogi: 2289 pcs</p> <p>RFQ</p>
 <p>62S11-L9-020SH Proizvajalci: Grayhill, Inc. Opis: ROTARY ENCODER OPTICAL 32PPR Na zalogi: 1952 pcs</p> <p>RFQ</p>	 <p>62S11-M0-050C Proizvajalci: Grayhill, Inc. Opis: ROTARY ENCODER OPT 32PPR 5" CBL Na zalogi: 2292 pcs</p> <p>RFQ</p>

Copyright © 2020 Zanesljivo Distributer elektronskih komponent

E-naslov: Info@infinity-electronic.com

Naslov: 17F, komercialna stavba Gaylord, 114-118 cesta Lockhart, Wan Chai, Hong Kong

