



Grayhill, Inc.

## 62S11-L9-020C

Številka dela:

62S11-L9-020C

Proizvajalec / znamka:

Grayhill, Inc.

Opis izdelka

ROTARY ENCODER OPTICAL 32PPR

Podatkovni listi:

 62S11-L9-020C.pdf

Status RoHS

 Skladen brez svinca / RoHS

Stanje zalog

1773 pcs stock

Iz ladje

Hong Kong

Način pošiljanja

DHL/Fedex/TNT/UPS/EMS

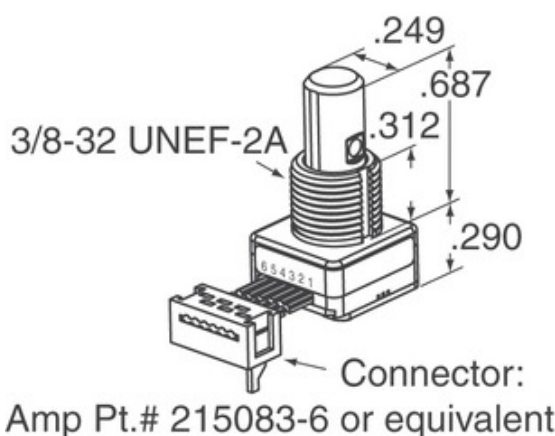

Slika je lahko reprezentativna. Oglejte si specifikacije za podrobnosti izdelka.





### Specifikacije 62S11-L9-020C

ŠTEVILKA DELA	62S11-L9-020C
PROIZVAJALEC	Grayhill, Inc.
OPIS	ROTARY ENCODER OPTICAL 32PPR
STATUS SVOBODNEGA STATUSA / ROHS	Skladen brez svinca / RoHS
KOLIČINA NA VOLJO	1773 pcs
PODATKOVNI LIST	 62S11-L9-020C.pdf
NAPETOST - OSKRBA	5V
SKLOP ZAKLJUČKA	Cable with Connector
SERIJA	62S
ROTACIJSKO ŽIVLJENJE (CIKLI MIN)	1M
STIKI NA REVOLUCIJO	32
VRSTA IZHODA	Quadrature (Incremental)
DRUGA IMENA	62S11L9020C
USMERJENOST	Vertical
TIP MONTAŽE	Panel Mount
RAVEN OBČUTLJIVOSTI NA VLAGO (MSL)	1 (Unlimited)
STATUS SVOBODNEGA STATUSA / ROHS	Lead free / RoHS Compliant
TIP DAJALNIKA	Optical
PRIDRŽANJE	Yes
VGRAJEN STIKALO	Yes
TIP AKTUATORJA	1/4" Dia Flatted End

### Sorodne oznake

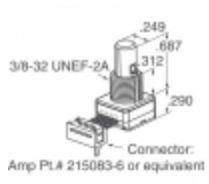
Grayhill, Inc. 62S11-L9-020C	62S11-L9-020C Distributer	62S11-L9-020C Dobavitelj
Cena 62S11-L9-020C	Slike 62S11-L9-020C	Slika 62S11-L9-020C
62S11-L9-020C PDF Datasheet	62S11-L9-020C Prenesi podatkovni list	62S11-L9-020C Datasheet
Zaloga 62S11-L9-020C	Kupi 62S11-L9-020C	Kupi Grayhill, Inc. 62S11-L9-020C
Grayhill, Inc. 62S11-L9-020C	Grayhill, Inc. Dobavitelj	Distributer Grayhill, Inc.
Grayhill, Inc. 62S11-L9-020C	Grayhill Inc. 62S11-L9-020C	

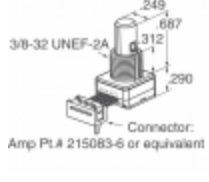
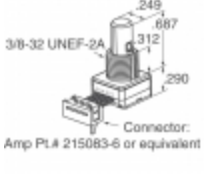
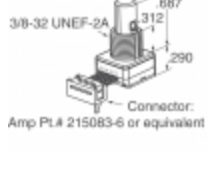
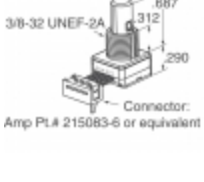
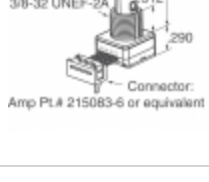
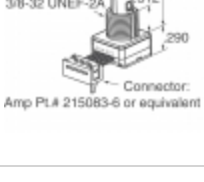
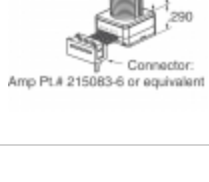
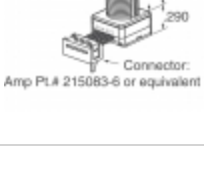
### Podobni izdelki

 <p><b>62S11-L5-050CH</b> Proizvajalci: Grayhill, Inc. Opis: ROTARY ENCODER OPTICAL 32PPR Na zalogi: 2186 pcs</p> <p><b>RFQ</b></p>	 <p><b>62S11-L5-PH</b> Proizvajalci: Grayhill, Inc. Opis: ROTARY ENCODER OPTICAL 32PPR Na zalogi: 2218 pcs</p> <p><b>RFQ</b></p>
 <p><b>62S11-L9-PH</b> Proizvajalci: Grayhill, Inc. Opis: ROTARY ENCODER OPTICAL 32PPR Na zalogi: 1972 pcs</p> <p><b>RFQ</b></p>	 <p><b>62S11-L9-020CH</b> Proizvajalci: Grayhill, Inc. Opis: ROTARY ENCODER OPTICAL 32PPR Na zalogi: 2264 pcs</p> <p><b>RFQ</b></p>
 <p><b>62S11-L9-040C</b> Proizvajalci: Grayhill, Inc. Opis: ROTARY ENCODER OPTICAL 32PPR Na zalogi: 1938 pcs</p> <p><b>RFQ</b></p>	 <p><b>62S11-L9-020S</b> Proizvajalci: Grayhill, Inc. Opis: ROTARY ENCODER OPTICAL 32PPR Na zalogi: 2134 pcs</p> <p><b>RFQ</b></p>
 <p><b>62S11-L9-020SH</b> Proizvajalci: Grayhill, Inc. Opis: ROTARY ENCODER OPTICAL 32PPR Na zalogi: 1952 pcs</p> <p><b>RFQ</b></p>	 <p><b>62S11-L5-040C</b> Proizvajalci: Grayhill, Inc. Opis: ROTARY ENCODER OPTICAL 32PPR Na zalogi: 1990 pcs</p> <p><b>RFQ</b></p>
 <p><b>62S11-L5-035C</b> Proizvajalci: Grayhill, Inc. Opis: ROTARY ENCODER OPTICAL 32PPR Na zalogi: 1861 pcs</p> <p><b>RFQ</b></p>	 <p><b>62S11-L5-060C</b> Proizvajalci: Grayhill, Inc. Opis: ROTARY ENCODER OPTICAL 32PPR Na zalogi: 2163 pcs</p> <p><b>RFQ</b></p>
 <p><b>62S11-L5-P</b> Proizvajalci: Grayhill, Inc. Opis: ROTARY ENCODER OPTICAL 32PPR Na zalogi: 2265 pcs</p> <p><b>RFQ</b></p>	 <p><b>62S11-M0-020C</b> Proizvajalci: Grayhill, Inc. Opis: ROTARY ENCODER OPT 32PPR 2" CBL Na zalogi: 1812 pcs</p> <p><b>RFQ</b></p>

Copyright © 2020 Zanesljivo Distributer elektronskih komponent

E-naslov: Info@infinity-electronic.com

Naslov: 17F, komercialna stavba Gaylord, 114-118 cesta Lockhart, Wan Chai, Hong Kong

