



Grayhill, Inc.

62S11-M9-050C

Številka dela:

62S11-M9-050C

Proizvajalec / znamka:

Grayhill, Inc.

Opis izdelka

ROTARY ENCODER OPTICAL 32PPR

Podatkovni listi:

 62S11-M9-050C.pdf

Status RoHS

 Skladen brez svinca / RoHS

Stanje zalog

2082 pcs stock

Iz ladje

Hong Kong

Način pošiljanja

DHL/Fedex/TNT/UPS/EMS

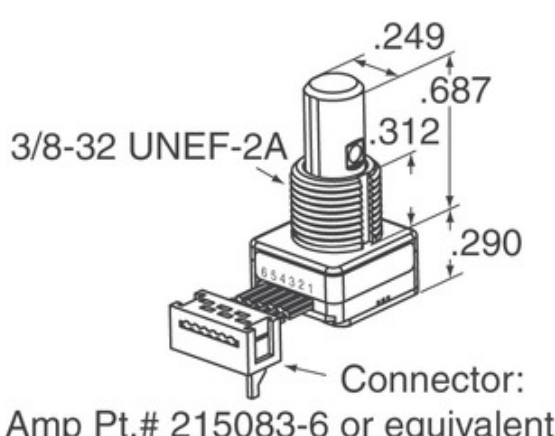

Slika je lahko reprezentativna. Oglejte si specifikacije za podrobnosti izdelka.

Specifikacije 62S11-M9-050C

ŠTEVILKA DELA	62S11-M9-050C
PROIZVAJALEC	Grayhill, Inc.
OPIS	ROTARY ENCODER OPTICAL 32PPR
STATUS SVOBODNEGA STATUSA / ROHS	Skladen brez svinca / RoHS
KOLIČINA NA VOLJO	2082 pcs
PODATKOVNI LIST	 62S11-M9-050C.pdf
NAPETOST - OSKRBA	5V
SKLOP ZAKLJUČKA	Cable with Connector
SERIJA	62S
ROTACIJSKO ŽIVLJENJE (CIKLI MIN)	1M
STIKI NA REVOLUCIJO	32
VRSTA IZHODA	Quadrature (Incremental)
DRUGA IMENA	62S11M9050C
USMERJENOST	Vertical
TIP MONTAŽE	Panel Mount
RAVEN OBČUTLJIVOSTI NA VLAGO (MSL)	1 (Unlimited)
STATUS SVOBODNEGA STATUSA / ROHS	Lead free / RoHS Compliant
TIP DAJALNIKA	Optical
PRIDRŽANJE	Yes
VGRAJEN STIKALO	Yes
TIP AKTUATORJA	1/4" Dia Flatted End

Sorodne oznake

Grayhill, Inc. 62S11-M9-050C	62S11-M9-050C Distributer	62S11-M9-050C Dobavitelj
Cena 62S11-M9-050C	Slike 62S11-M9-050C	Slika 62S11-M9-050C
62S11-M9-050C PDF Datasheet	62S11-M9-050C Prenesi podatkovni list	62S11-M9-050C Datasheet
Zaloga 62S11-M9-050C	Kupi 62S11-M9-050C	Kupi Grayhill, Inc. 62S11-M9-050C
Grayhill, Inc. 62S11-M9-050C	Grayhill, Inc. Dobavitelj	Distributer Grayhill, Inc.
Grayhill, Inc. 62S11-M9-050C	Grayhill Inc. 62S11-M9-050C	

Podobni izdelki

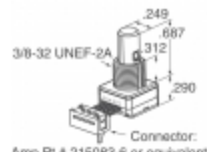
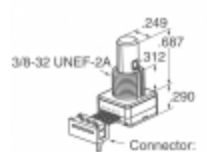
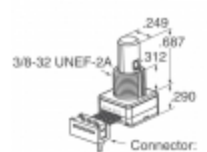
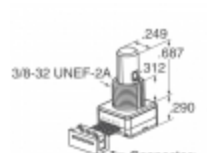
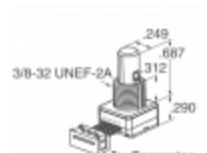
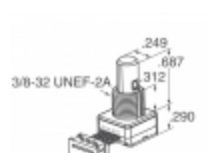
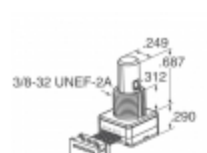
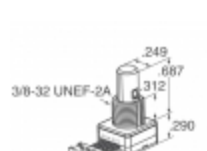
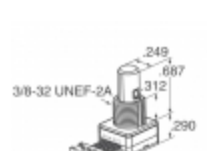
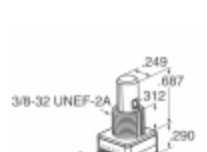
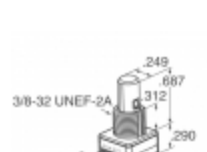
 <p>62S11-M9-020CH Proizvajalci: Grayhill, Inc. Opis: ROTARY ENCODER OPTICAL 32PPR Na zalogi: 2097 pcs</p> <p>RFQ</p>	 <p>62S11-M9-040SH Proizvajalci: Grayhill, Inc. Opis: ROTARY ENCODER OPT 32PPR 4" CBL Na zalogi: 1879 pcs</p> <p>RFQ</p>
 <p>62S11-M9-120S Proizvajalci: Grayhill, Inc. Opis: ROTARY ENCODER OPTICAL 32PPR Na zalogi: 2092 pcs</p> <p>RFQ</p>	 <p>62S11-M9-095CH Proizvajalci: Grayhill, Inc. Opis: ROTARY ENCODER OPTICAL 32PPR Na zalogi: 1978 pcs</p> <p>RFQ</p>
 <p>62S11-M9-P Proizvajalci: Grayhill, Inc. Opis: ROTARY ENCODER OPTICAL 32PPR Na zalogi: 1799 pcs</p> <p>RFQ</p>	 <p>62S11-M9-020S Proizvajalci: Grayhill, Inc. Opis: ROTARY ENCODER OPTICAL 32PPR Na zalogi: 2269 pcs</p> <p>RFQ</p>
 <p>62S11-M9-100S Proizvajalci: Grayhill, Inc. Opis: ROTARY ENCODER OPTICAL 32PPR Na zalogi: 2008 pcs</p> <p>RFQ</p>	 <p>62S11-M9-060C Proizvajalci: Grayhill, Inc. Opis: ROTARY ENCODER OPTICAL 32PPR Na zalogi: 2060 pcs</p> <p>RFQ</p>
 <p>62S11-M9-040C Proizvajalci: Grayhill, Inc. Opis: ROTARY ENCODER OPTICAL 32PPR Na zalogi: 1933 pcs</p> <p>RFQ</p>	 <p>62S11-M9-025S Proizvajalci: Grayhill, Inc. Opis: ROTARY ENCODER OPTICAL 32PPR Na zalogi: 2070 pcs</p> <p>RFQ</p>
 <p>62S11-M9-030S Proizvajalci: Grayhill, Inc. Opis: ROTARY ENCODER OPTICAL 32PPR Na zalogi: 1918 pcs</p> <p>RFQ</p>	 <p>62S11-M9-100C Proizvajalci: Grayhill, Inc. Opis: ROTARY ENCODER OPTICAL 32PPR Na zalogi: 2260 pcs</p> <p>RFQ</p>

Copyright © 2020 Zanesljivo Distributer elektronskih komponent

E-naslov: Info@infinity-electronic.com

Naslov: 17F, komercialna stavba Gaylord, 114-118 cesta Lockhart, Wan Chai, Hong Kong

