



Grayhill, Inc.

## 62S11-M0-030CH

Številka dela:

62S11-M0-030CH

Proizvajalec / znamka:

Grayhill, Inc.

Opis izdelka

ROTARY ENCODER OPTICAL 32PPR

Podatkovni listi:

 62S11-M0-030CH.pdf

Status RoHS

 Skladen brez svinca / RoHS

Stanje zalog

2151 pcs stock

Iz ladje

Hong Kong

Način pošiljanja

DHL/Fedex/TNT/UPS/EMS

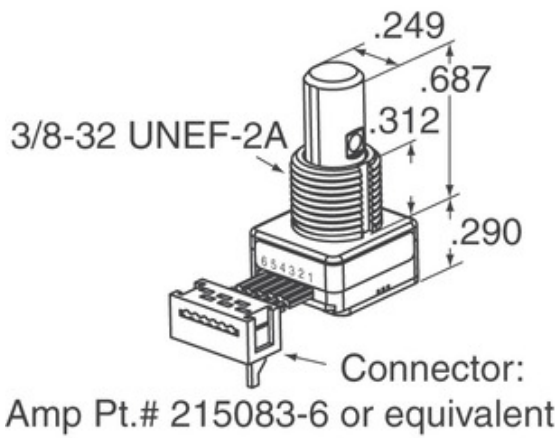

Slika je lahko reprezentativna. Oglejte si specifikacije za podrobnosti izdelka.







### Specifikacije 62S11-M0-030CH

ŠTEVILKA DELA	62S11-M0-030CH
PROIZVAJALEC	Grayhill, Inc.
OPIS	ROTARY ENCODER OPTICAL 32PPR
STATUS SVOBODNEGA STATUSA / ROHS	Skladen brez svinca / RoHS
KOLIČINA NA VOLJO	2151 pcs
PODATKOVNI LIST	 62S11-M0-030CH.pdf
NAPETOST - OSKRBA	5V
SKLOP ZAKLJUČKA	Cable with Connector
SERIJA	62S
ROTACIJSKO ŽIVLJENJE (CIKLI MIN)	1M
STIKI NA REVOLUCIJO	32
VRSTA IZHODA	Quadrature (Incremental)
DRUGA IMENA	62S11M0030CH
USMERJENOST	Vertical
TIP MONTAŽE	Panel Mount
RAVEN OBČUTLJIVOSTI NA VLAGO (MSL)	1 (Unlimited)
STATUS SVOBODNEGA STATUSA / ROHS	Lead free / RoHS Compliant
TIP DAJALNIKA	Optical
PRIDRŽANJE	Yes
VGRAJEN STIKALO	No
TIP AKTUATORJA	1/4" Dia Flatted End

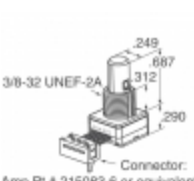
### Sorodne oznake

Grayhill, Inc. 62S11-M0-030CH	62S11-M0-030CH Distributer	62S11-M0-030CH Dobavitelj
Cena 62S11-M0-030CH	Slika 62S11-M0-030CH	Slika 62S11-M0-030CH
62S11-M0-030CH PDF Datasheet	62S11-M0-030CH Prenesi podatkovni list	62S11-M0-030CH Datasheet
Zaloga 62S11-M0-030CH	Kupi 62S11-M0-030CH	Kupi Grayhill, Inc. 62S11-M0-030CH
Grayhill, Inc. 62S11-M0-030CH	Grayhill, Inc. Dobavitelj	Distributer Grayhill, Inc.
Grayhill, Inc. 62S11-M0-030CH	Grayhill Inc. 62S11-M0-030CH	

### Podobni izdelki

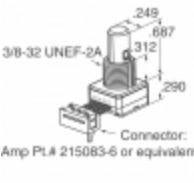
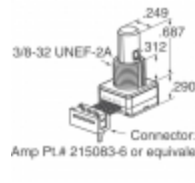
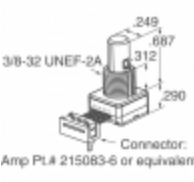
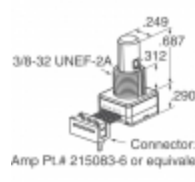
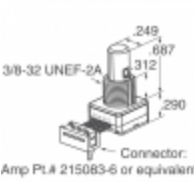
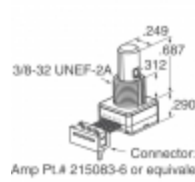
 <p><b>62S11-L9-040C</b> Proizvajalci: Grayhill, Inc. Opis: ROTARY ENCODER OPTICAL 32PPR Na zalogi: 1938 pcs</p> <p><b>RFQ</b></p>	 <p><b>62S11-M0-060C</b> Proizvajalci: Grayhill, Inc. Opis: ROTARY ENCODER OPT 32PPR 6" CBL Na zalogi: 2289 pcs</p> <p><b>RFQ</b></p>
 <p><b>62S11-M0-210SH</b> Proizvajalci: Grayhill, Inc. Opis: ROTARY ENCODER OPT 32PPR 20" CBL Na zalogi: 2126 pcs</p> <p><b>RFQ</b></p>	 <p><b>62S11-M0-050C</b> Proizvajalci: Grayhill, Inc. Opis: ROTARY ENCODER OPT 32PPR 5" CBL Na zalogi: 2292 pcs</p> <p><b>RFQ</b></p>
 <p><b>62S11-M0-040CH</b> Proizvajalci: Grayhill, Inc. Opis: ROTARY ENCODER OPT 32PPR 2" CBL Na zalogi: 1915 pcs</p> <p><b>RFQ</b></p>	 <p><b>62S11-M0-060CH</b> Proizvajalci: Grayhill, Inc. Opis: ROTARY ENCODER OPTICAL 32PPR Na zalogi: 1968 pcs</p> <p><b>RFQ</b></p>
 <p><b>62S11-M0-020C</b> Proizvajalci: Grayhill, Inc. Opis: ROTARY ENCODER OPT 32PPR 2" CBL Na zalogi: 1812 pcs</p> <p><b>RFQ</b></p>	 <p><b>62S11-M0-020SH</b> Proizvajalci: Grayhill, Inc. Opis: ROTARY ENCODER OPT 32PPR 2" CBL Na zalogi: 2051 pcs</p> <p><b>RFQ</b></p>
 <p><b>62S11-L9-PH</b> Proizvajalci: Grayhill, Inc. Opis: ROTARY ENCODER OPTICAL 32PPR Na zalogi: 1972 pcs</p> <p><b>RFQ</b></p>	 <p><b>62S11-M0-200S</b> Proizvajalci: Grayhill, Inc. Opis: ROTARY ENCODER OPTICAL 32PPR Na zalogi: 2199 pcs</p> <p><b>RFQ</b></p>
 <p><b>62S11-L9-020SH</b> Proizvajalci: Grayhill, Inc. Opis: ROTARY ENCODER OPTICAL 32PPR Na zalogi: 1952 pcs</p> <p><b>RFQ</b></p>	 <p><b>62S11-L9-020S</b> Proizvajalci: Grayhill, Inc. Opis: ROTARY ENCODER OPTICAL 32PPR Na zalogi: 2134 pcs</p> <p><b>RFQ</b></p>

Copyright © 2020 Zanesljivo Distributer elektronskih komponent

E-naslov: Info@infinity-electronic.com

Naslov: 17F, komercialna stavba Gaylord, 114-118 cesta Lockhart, Wan Chai, Hong Kong

