

## Thermally-Enhanced High Power RF LDMOS FET 60 W, 28 V, 1805 – 1880 MHz

### Description

The PXAC180602MD is a 60-watt LDMOS FET with an asymmetrical design intended for use in multi-standard cellular power amplifier applications in the 1805 to 1880 MHz frequency band. Features include dual-path design, input matching, high gain and thermally-enhanced package with earless flanges. Manufactured with Infineon's advanced LDMOS process, this device provides excellent thermal performance and superior reliability.

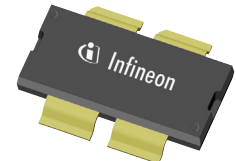

PXAC180602MD  
Package PG-HB1DSO-4-1

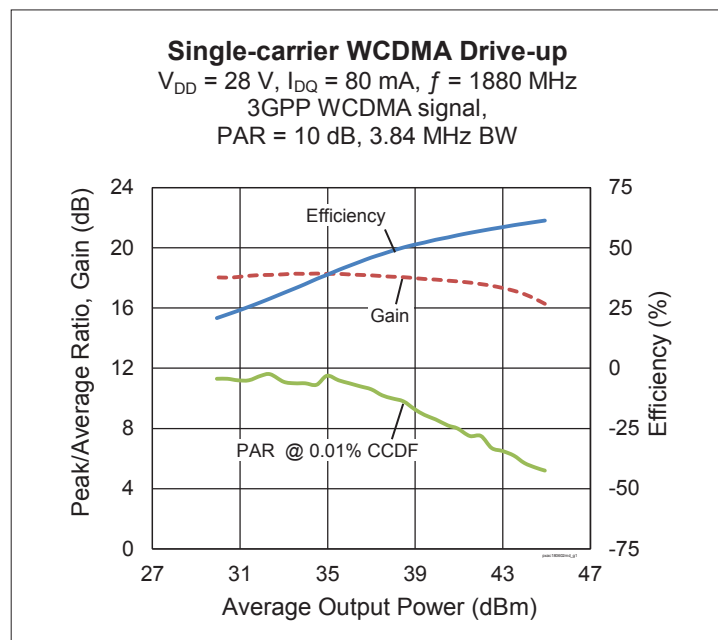

### Features

- Broadband internal input and output matching
- Asymmetric Doherty design
  - Main : P<sub>1dB</sub> = 20 W Typ
  - Peak : P<sub>1dB</sub> = 40 W Typ
- Typical Pulsed CW performance, 1880 MHz, 28 V, 160 μs pulse width, 10% duty cycle, class AB, Doherty Configuration
  - Output power at P<sub>1dB</sub> = 10 W
  - Efficiency = 58%
  - Gain at P<sub>3dB</sub> = 19 dB
- Integrated ESD protection
- Human Body Model, Class 1B (per ANSI/ESDA/ JEDEC JS-001)
- Low thermal resistance
- Pb-free and RoHS compliant

### RF Characteristics

#### Single-carrier WCDMA Specifications (tested in Infineon production Doherty test fixture)

$V_{DD} = 28\text{ V}$ ,  $I_{DQ} = 80\text{ mA}$ ,  $P_{OUT} = 8.9\text{ W avg}$ ,  $V_{GSPK} = 160\text{ mA} - 1.3\text{ V}$ ,  $f_1 = 1840\text{ MHz}$ , 3GPP signal, channel bandwidth = 3.84 MHz, peak/average = 10 dB @ 0.01% CCDF

Characteristic	Symbol	Min	Typ	Max	Unit
Gain	$G_{ps}$	16.5	17.7	—	dB
Drain Efficiency	$\eta_D$	51.0	54.5	—	%
Adjacent Channel Power Ratio	ACPR	—	-27.6	-25	dBc

All published data at  $T_{CASE} = 25^\circ\text{C}$  unless otherwise indicated

**ESD:** Electrostatic discharge sensitive device—observe handling precautions!

**DC Characteristics** (each side)

Characteristic	Conditions	Symbol	Min	Typ	Max	Unit
Drain-Source Breakdown Voltage	$V_{GS} = 0\text{ V}$ , $I_{DS} = 10\text{ mA}$	$V_{(BR)DSS}$	65	—	—	V
Drain Leakage Current	$V_{DS} = 28\text{ V}$ , $V_{GS} = 0\text{ V}$	$I_{DSS}$	—	—	1	$\mu\text{A}$
	$V_{DS} = 63\text{ V}$ , $V_{GS} = 0\text{ V}$	$I_{DSS}$	—	—	10	$\mu\text{A}$
On-State Resistance (main)	$V_{GS} = 10\text{ V}$ , $V_{DS} = 0.1\text{ V}$	$R_{DS(on)}$	—	0.76	—	$\Omega$
	(peak) $V_{GS} = 10\text{ V}$ , $V_{DS} = 0.1\text{ V}$	$R_{DS(on)}$	—	0.36	—	$\Omega$
Operating Gate Voltage (main)	$V_{DS} = 26\text{ V}$ , $I_{DQ} = 80\text{ mA}$	$V_{GS}$	2.3	2.6	3.0	V
	(peak) $V_{DS} = 26\text{ V}$ , $I_{DQ} = 0\text{ mA}$	$V_{GS}$	0.8	1.4	1.8	V
Gate Leakage Current	$V_{GS} = 10\text{ V}$ , $V_{DS} = 0\text{ V}$	$I_{GSS}$	—	—	1	$\mu\text{A}$

**Maximum Ratings**

Parameter	Symbol	Value	Unit
Drain-Source Voltage	$V_{DSS}$	65	V
Gate-Source Voltage	$V_{GS}$	-6 to +10	V
Operating Voltage	$V_{DD}$	0 to +32	V
Junction Temperature	$T_J$	225	$^{\circ}\text{C}$
Storage Temperature Range	$T_{STG}$	-65 to +150	$^{\circ}\text{C}$
Thermal Resistance (Doherty, $T_{CASE} = 70^{\circ}\text{C}$ , 55 W CW)	$R_{\theta JC}$	2.4	$^{\circ}\text{C/W}$

**Ordering Information**

Type and Version	Order Code	Package Description	Shipping
PXAC180602MD V1 R500	PXAC180602MDV1R500XUMA1	PG-HB1DSO-4-1	Tape & Reel, 500 pcs

**Typical Performance** (data taken in a production Doherty test fixture)

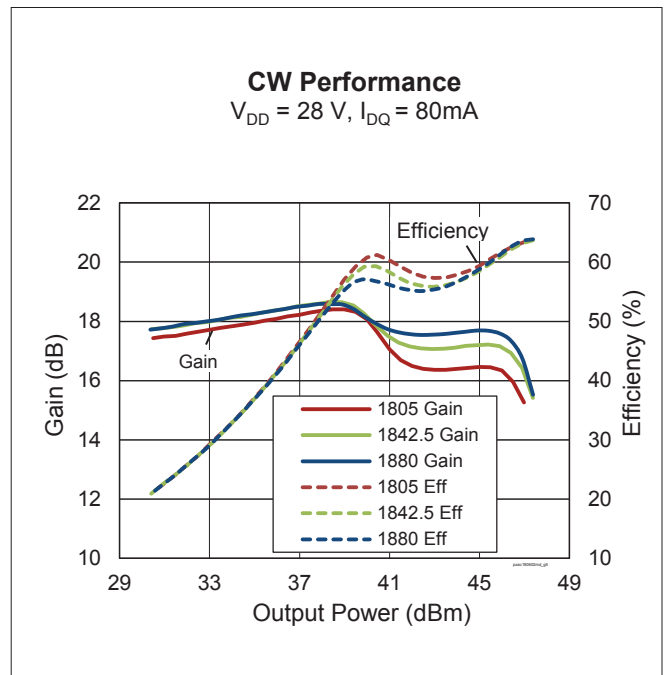
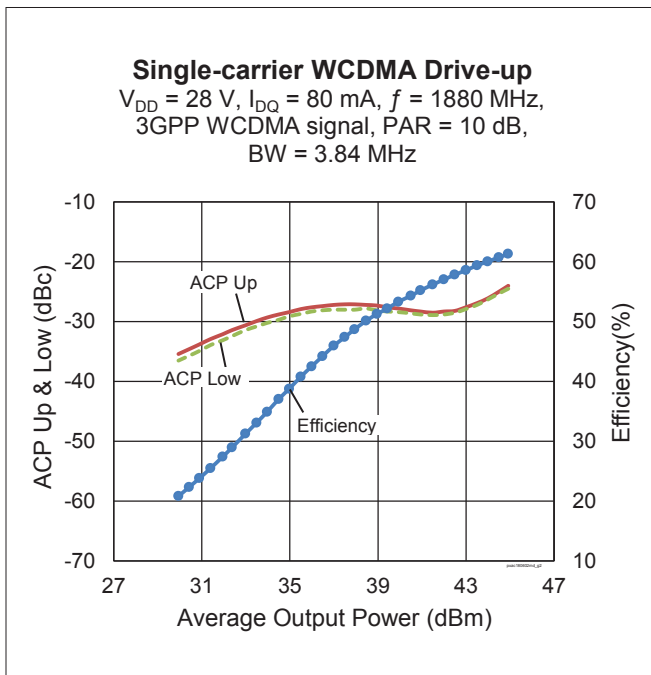
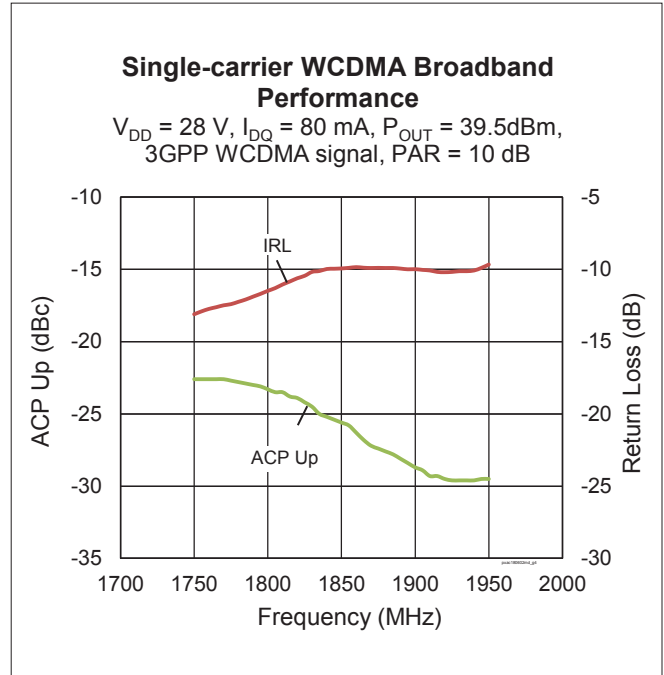
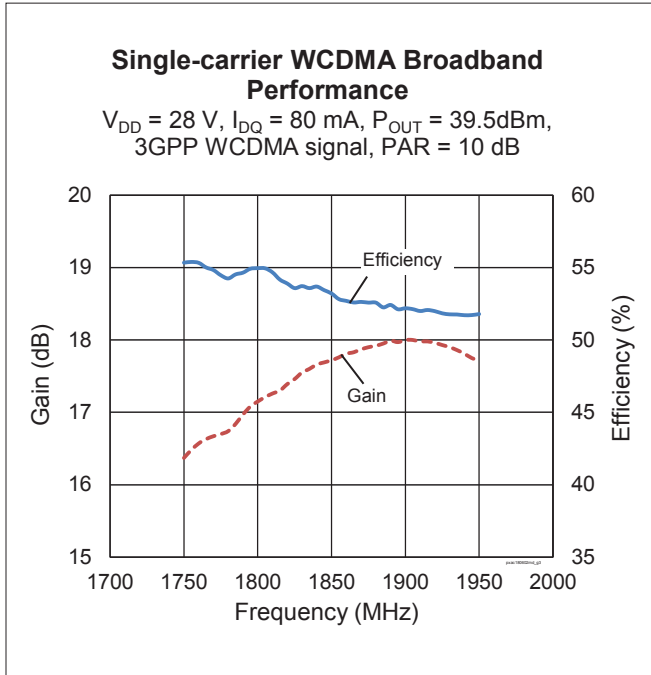

Typical Performance (cont.)

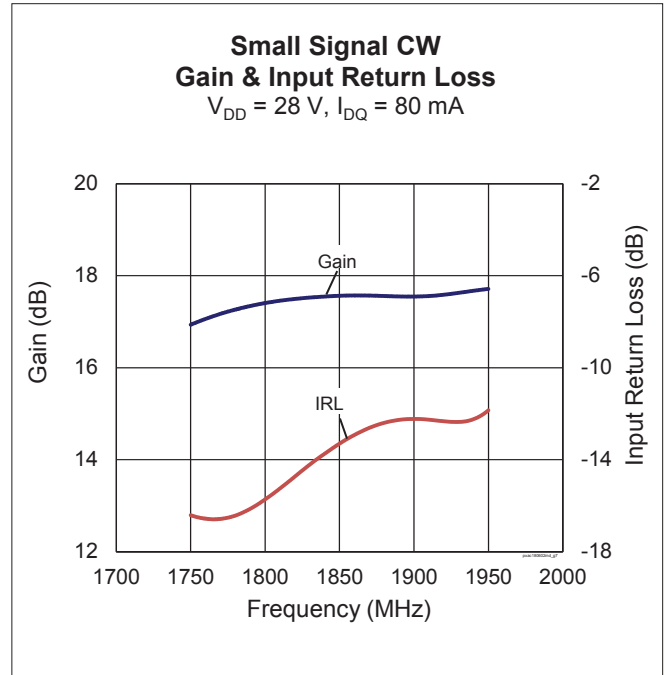
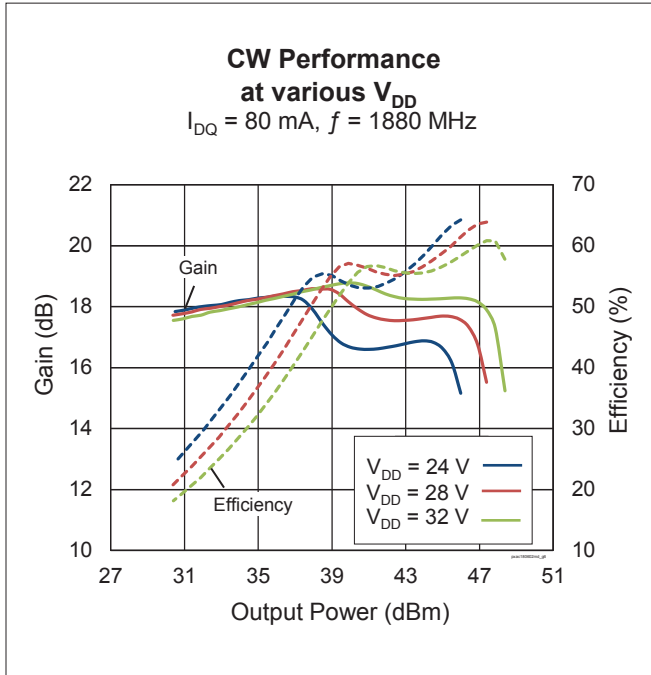

## Load Pull Performance – P<sub>1dB</sub>

Main Side Load Pull Performance – CW signal: V<sub>DD</sub> = 28 V, I<sub>DQ</sub> = 85 mA, Class AB

		P <sub>1dB</sub>									
		Max Output Power					Max PAE				
Freq [MHz]	Z <sub>s</sub> [Ω]	Z <sub>l</sub> [Ω]	Gain [dB]	P <sub>OUT</sub> [dBm]	P <sub>OUT</sub> [W]	PAE [%]	Z <sub>l</sub> [Ω]	Gain [dB]	P <sub>OUT</sub> [dBm]	P <sub>OUT</sub> [W]	PAE [%]
1805	7.3-j16.9	8.8-j10.33	20.55	43.62	23	63.4	12.8-j1.9	21.86	41.73	14.89	70.8
1843	6.6-j18.9	8.4-j10.4	20.71	43.29	21.33	60.8	11.8-j4.4	22.12	42.10	16.22	69.6
1880	8.3-j21.5	7.5-j9.3	20.67	43.30	21.38	63.4	9.3-j3.9	21.86	41.87	15.38	69.4

Peak Side Load Pull Performance – CW signal: V<sub>DD</sub> = 28 V, V<sub>GSPK</sub> = 1.4 V

		P <sub>1dB</sub>									
		Max Output Power					Max PAE				
Freq [MHz]	Z <sub>s</sub> [Ω]	Z <sub>l</sub> [Ω]	Gain [dB]	P <sub>OUT</sub> [dBm]	P <sub>OUT</sub> [W]	PAE [%]	Z <sub>l</sub> [Ω]	Gain [dB]	P <sub>OUT</sub> [dBm]	P <sub>OUT</sub> [W]	PAE [%]
1805	13.5 – j0.7	5.2 – j8.4	16.92	46.35	43.15	63.8	9.9 – j8.0	17.51	45.09	32.28	72.3
1842	7.7 – j0.2	4.7 – j8.4	16.8	46.43	43.95	63.3	9.0 – j7.1	17.47	45.14	32.66	72.7
1880	4.8 – j0.2	4.4 – j8.5	16.7	46.42	43.85	62.8	8.6 – j6.8	17.36	44.99	31.55	72.4

## Load Pull Performance – P<sub>3dB</sub>

Main Side Load Pull Performance – CW signal: V<sub>DD</sub> = 28 V, I<sub>DQ</sub> = 85 mA, Class AB

		P <sub>3dB</sub>									
		Max Output Power					Max PAE				
Freq [MHz]	Z <sub>s</sub> [Ω]	Z <sub>l</sub> [Ω]	Gain [dB]	P <sub>OUT</sub> [dBm]	P <sub>OUT</sub> [W]	PAE [%]	Z <sub>l</sub> [Ω]	Gain [dB]	P <sub>OUT</sub> [dBm]	P <sub>OUT</sub> [W]	PAE [%]
1805	7.3-j16.9	9.0-j11.7	18.65	44.30	26.92	63.8	13.1-j7.1	19.78	43.28	21.28	70.8
1843	6.6-j18.9	9.0-j11.7	19	43.98	25	62.0	11.5-j5.9	20	42.94	19.68	69.5
1880	8.3-j21.5	8.9-j11.9	19.26	43.89	24.5	61.7	11.1-j6.4	20.2	42.91	19.54	69.0

Peak Side Load Pull Performance – CW signal: V<sub>DD</sub> = 28 V, V<sub>GSPK</sub> = 1.4 V

		P <sub>3dB</sub>									
		Max Output Power					Max PAE				
Freq [MHz]	Z <sub>s</sub> [Ω]	Z <sub>l</sub> [Ω]	Gain [dB]	P <sub>OUT</sub> [dBm]	P <sub>OUT</sub> [W]	PAE [%]	Z <sub>l</sub> [Ω]	Gain [dB]	P <sub>OUT</sub> [dBm]	P <sub>OUT</sub> [W]	PAE [%]
1805	13.5 – j0.7	5.1 – j9.2	14.94	47.00	50.12	64.4	10.0 – j8.3	15.52	45.58	36.14	71.6
1842	7.7 – j0.2	5.0 – j9.2	14.9	47.00	50.1	64.6	9.3 – j7.7	15.45	45.67	36.9	72.0
1880	4.8 – j0.2	4.6 – j9.35	14.72	47.00	50.1	63.3	8.1 – j7.2	15.37	45.74	37.5	71.6

Reference Circuit , 1805 – 1880 MHz

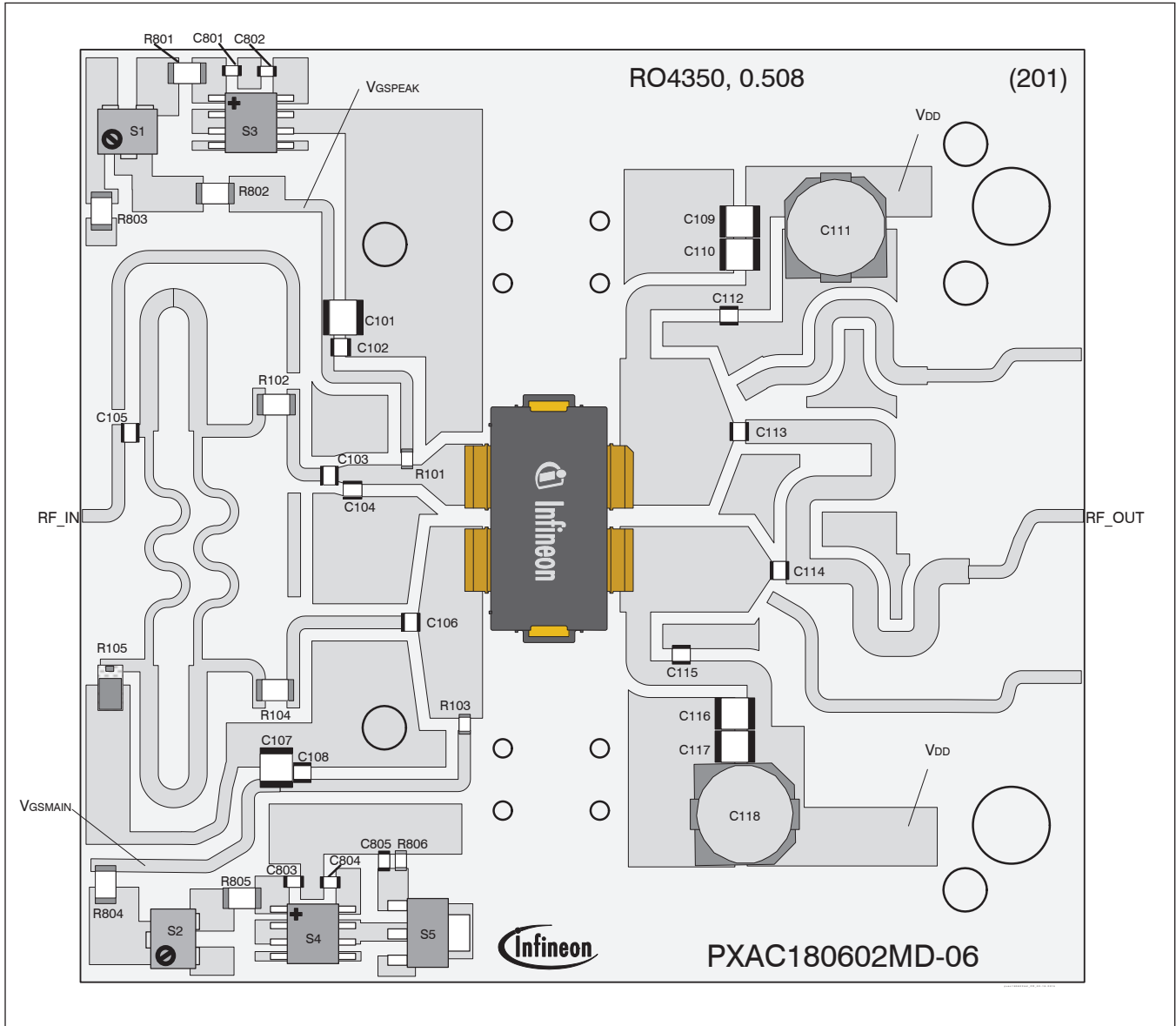

Reference circuit assembly diagram (not to scale)

**Reference Circuit** (cont.)

**Reference Circuit Assembly**

DUT	PXAC180602MD V1
Test Fixture Part No.	LTA/PXAC180602MD V1
PCB	Rogers 4350, 0.508 mm [0.020"] thick, 2 oz. copper, $\epsilon_r = 3.66$ , $f = 1805 - 1880$ MHz
Find Gerber files for this test fixture on the Infineon Web site at <a href="http://www.infineon.com/rfpower">http://www.infineon.com/rfpower</a>	

**Components Information**

Component	Description	Suggested Manufacturer	P/N
<b>Input</b>			
C101, C107	Capacitor, 10 $\mu$ F	Taiyo Yuden	UMK325C7106MM-T
C102, C103, C106, C108	Capacitor, 24 pF	ATC	ATC100A240JW150XB
C104	Capacitor, 2.4 pF	ATC	ATC100A2R4CW150XB
C105	Capacitor, 15 pF	ATC	ATC100A150JW150XB
C801, C802, C803, C804, C805	Capacitor, 1000 pF	Panasonic Electronic Components	ECJ-1VB1H102K
R101, R103	Resistor, 10 $\Omega$	Panasonic Electronic Components	ERJ-3GEYJ100V
R102, R104	Resistor, 0.0 $\Omega$	Panasonic Electronic Components	ERJ-8GEY0R00V
R105	Resistor, 50 $\Omega$	Anaren	C16A50Z4
R801, R805	Resistor, 100 $\Omega$	Panasonic Electronic Components	ERJ-8GEYJ101V
R802, R803, R804	Resistor, 10 $\Omega$	Panasonic Electronic Components	ERJ-8GEYJ100V
R806	Resistor, 1.3k	Panasonic Electronic Components	ERJ-3GEYJ132V
S1, S2	Potentiometer, 2k $\Omega$	Bourns Inc.	3224W-1-202E
S3, S4	Voltage Regulator	Texas Instruments	LM78L05ACM
S5	Transistor	Infineon Technologies	BCP56
<b>Output</b>			
C109, C110, C116, C117	Capacitor, 10 $\mu$ F	Taiyo Yuden	UMK325C7106MM-T
C112, C113, C114, C115	Capacitor, 24 pF	ATC	ATC100A240JW150XB
C111, C118	Capacitor, 100 $\mu$ F	Panasonic Electronic Components	EEE-FP1V101AP

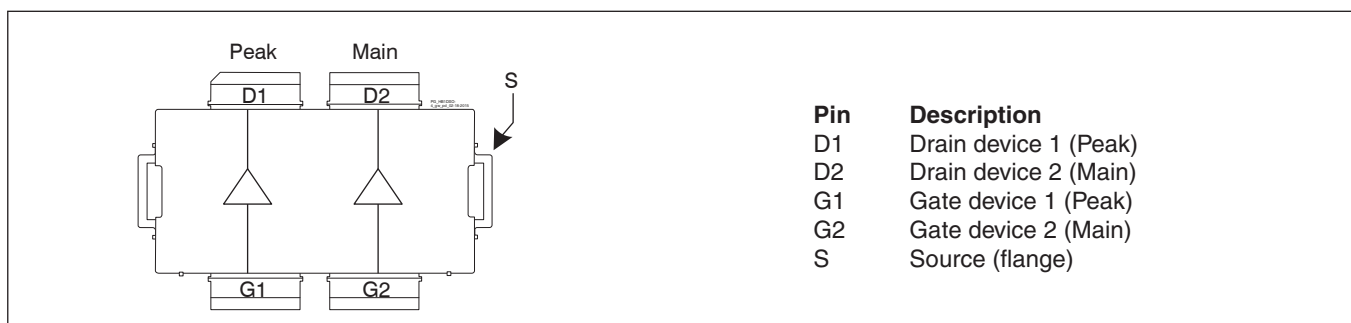
**Pinout Diagram** (top view)

*Lead connections for PXAC180602MD*

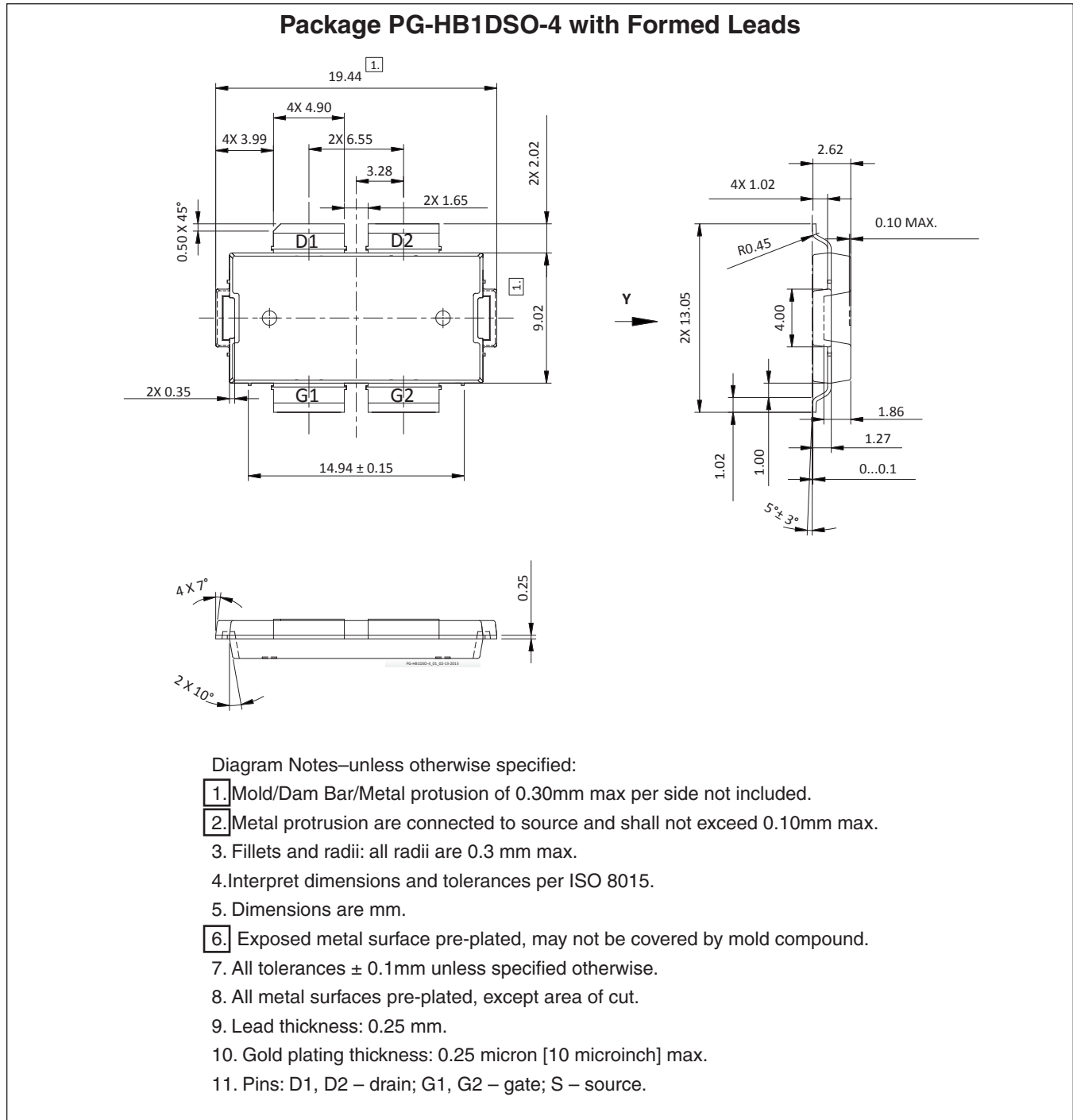
### Package Outline Specifications





Package Outline Specifications (cont.)

Package PG-HB1DSO-4 with Formed Leads (bottom side)

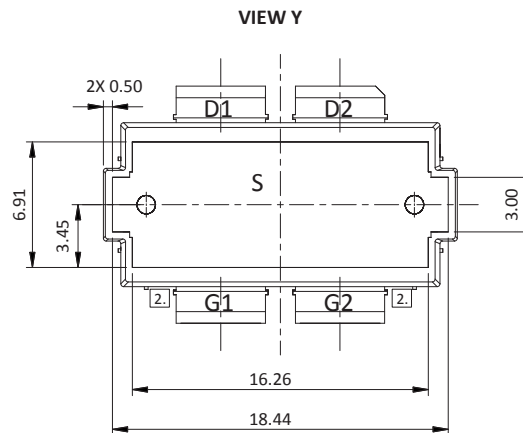

Diagram Notes—unless otherwise specified:

1. Mold/Dam Bar/Metal protrusion of 0.30mm max per side not included.
2. Metal protrusion are connected to source and shall not exceed 0.10mm max.
3. Fillets and radii: all radii are 0.3 mm max.
4. Interpret dimensions and tolerances per ISO 8015.
5. Dimensions are mm.
6. Exposed metal surface pre-plated, may not be covered by mold compound.
7. All tolerances  $\pm 0.1$ mm unless specified otherwise.
8. All metal surfaces pre-plated, except area of cut.
9. Lead thickness: 0.25 mm.
10. Gold plating thickness: 0.25 micron [10 microinch] max.
11. Pins: D1, D2 – drain; G1, G2 – gate; S – source.

Find the latest and most complete information about products and packaging at the Infineon Internet page <http://www.infineon.com/rfpower>

## Revision History

Revision	Date	Data Sheet Type	Page	Subjects (major changes since last revision)
01	2013-11-12	Advance	All	Data Sheet reflects advance specification for product development
01.1	2014-04-15	Advance	1 3	Added package, updated package identification updated package identification
02	2015-02-13	Production	All	Data Sheet reflects released product specification - updated features, RF & DC characteristics, Maximum Ratings, Ordering Information, added graphs, loadpull information and reference circuit, updated package outline
02.1	2015-06-18	Production	7	Corrected test fix part no. to LTA

### We Listen to Your Comments

Any information within this document that you feel is wrong, unclear or missing at all?  
Your feedback will help us to continuously improve the quality of this document.  
Please send your proposal (including a reference to this document) to:

[highpowerRF@infineon.com](mailto:highpowerRF@infineon.com)

To request other information, contact us at:  
+1 877 465 3667 (1-877-GO-LDMOS) USA  
or +1 408 776 0600 International



**Edition 2015-06-18**

**Published by  
Infineon Technologies AG  
85579 Neubiberg, Germany**

**© 2014 Infineon Technologies AG  
All Rights Reserved.**

### Legal Disclaimer

The information given in this document shall in no event be regarded as a guarantee of conditions or characteristics. With respect to any examples or hints given herein, any typical values stated herein and/or any information regarding the application of the device, Infineon Technologies hereby disclaims any and all warranties and liabilities of any kind, including without limitation, warranties of non-infringement of intellectual property rights of any third party.

### Information

For further information on technology, delivery terms and conditions and prices, please contact the nearest Infineon Technologies Office ([www.infineon.com/rfpower](http://www.infineon.com/rfpower)).

### Warnings

Due to technical requirements, components may contain dangerous substances. For information on the types in question, please contact the nearest Infineon Technologies Office.

Infineon Technologies components may be used in life-support devices or systems only with the express written approval of Infineon Technologies, if a failure of such components can reasonably be expected to cause the failure of that life-support device or system or to affect the safety or effectiveness of that device or system. Life support devices or systems are intended to be implanted in the human body or to support and/or maintain and sustain and/or protect human life. If they fail, it is reasonable to assume that the health of the user or other persons may be endangered.