

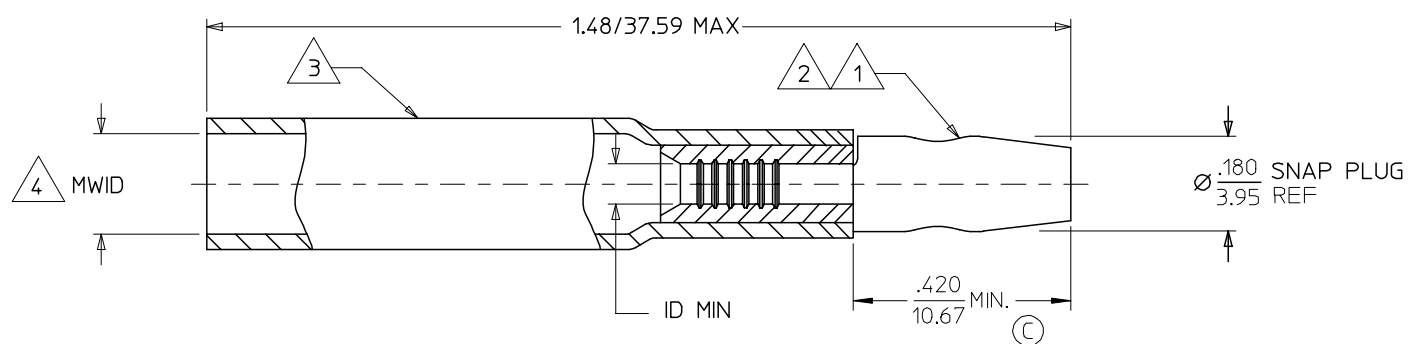







MATERIAL NUMBER	ENGINEERING NUMBER	WIRE AWG	MWID 	ID MIN	INSULATION COLOR
191640009	SA-259	22-18	.235/5.97	.054/1.35	RED
191640039	SB-279	16-14	.230/5.84	.080/2.03	BLUE



NOTE(S):

-  TERMINAL MATERIAL: COPPER ALLOY
-  FINISH: ELECTROTIN PLATE
-  INSULATION MATERIAL: HEAT SHRINKABLE TUBING WITH HOTMELT ADHESIVE INNER LINER. COLOR: SEE CHART
-  MWID: MAXIMUM WIRE INSULATION DIAMETER

SALES DRAWING

CHANGED MWID EC NO: ETC2007-0054 DRWN: JLOMASTR006/08/16 CHKD: RDEROSS 2006/08/16 APPR: JMACNEIL 2006/08/17	QUALITY SYMBOLS  -0  -0	GENERAL TOLERANCES (UNLESS SPECIFIED)		SCALE 1:1	DESIGN UNITS INCH	 THIRD ANGLE PROJECTION REVISE ON CAD ONLY		
				DIMENSION STYLE IN/MM			TITLE	
		4 PLACES ± --- ± --- 3 PLACES ± --- ± .010 2 PLACES ± 0.25 ± .02 1 PLACE ± 0.5 ± ---		ANGULAR ± 1°		DRAWN BY BENDERLE 2004/08/23		.180/4.57 SNAP PLUG NIAC 22-18 16-14 AWG
		DRAFT WHERE APPLICABLE MUST REMAIN WITHIN DIMENSIONS				CHECKED BY R DEROSS 2004/08/23		
				APPROVED BY RDEROSS 2004/08/23		MOLEX INCORPORATED MATERIAL NO. SEE CHART DOCUMENT NO. SD-19164-068 SHEET NO. 1 OF 1		

THIS DRAWING CONTAINS INFORMATION THAT IS PROPRIETARY TO MOLEX INCORPORATED AND SHOULD NOT BE USED WITHOUT WRITTEN PERMISSION