



SPECIFICATION FOR APPROVAL

Customer _____

Description _____ GT FAN _____

Part No. _____ REV. _____

Delta Model No. _____ GTW020EUB12 _____ REV. _____ 02 _____

Sample Issue No. _____

Sample Issue Date _____ Apr.26 2 0 1 3 _____

PLEASE SEND ONE COPY OF THIS SPECIFICATION BACK AFTER YOU SIGNED APPROVAL FOR PRODUCTION PRE-ARRANGMENT.

APPROVED BY: _____

DATE : _____

DELTA ELECTRONICS, INC.
TAOYUAN PLANT
252, SHANG YING ROAD, KUEI SAN INDUSTRIAL ZONE TAOYUAN
SHIEN, TAIWAN, R.O.C.
TEL:886-(0)3-3591968
FAX:886-(0)3-3591991

DELTA ELECTRONICS, INC.

252, SHANG YING ROAD, KUEI SAN
TAOYUAN HSIEN 333, TAIWAN, R. O. C.

TEL : 886-(0)3-3591968
FAX : 886-(0)3-3591991

STATEMENT OF DEVIATION

NONE

DESCRIPTION :

SPECIFICATION FOR APPROVAL

Customer:

Description:	GT FAN		
Customer P/N:		REV:	
Delta Model NO.:	GTW020EUB12	Safety Model NO.:	GTW020EUB12
Sample Rev:	02	Issue NO:	
Sample Issue Date:	APR.26 2013	Quantity:	

1. SCOPE:

THIS SPECIFICATION DEFINES THE ELECTRICAL AND MECHANICAL CHARACTERISTICS OF THIS AXIAL FAN.

2. NOMINAL DATA:

ITEM	DESCRIPTION
NOMINAL VOLTAGE	1 ϕ 230 VAC 50/60Hz
NOMINAL VOLTAGE RANGE	1 ϕ 200 - 240 VAC
INPUT POWER @ FREE-AIR	149 W
INPUT POWER @ MAX. LOAD	240 W
SPEED	6000 R.P.M. (REF.)
MAX. AIR FLOW (AT ZERO STATIC PRESSURE)	1081.74 (MIN. 973.57) M ³ /H 636.69 (MIN. 573.02) CFM
MAX.AIR PRESSURE (AT ZERO AIR FLOW)	1037.21 (MIN. 840.14) Pa 4.164 (MIN. 3.373) inchH ₂ O
ACOUSTICAL NOISE (AVG.) @ FREE-AIR	70.0 (MAX 74.0) dB(A)

- NOTES: 1. ALL READINGS ARE MEASURED AFTER STABLY WARMING UP THROUGH 10 MINUTES.
 2. STANDARD AIR PROPERTY IS AIR AT (Td) 25°C TEMPERATURE, (RH) 65% RELATIVE HUMIDITY, AND (Pb) 760 mmHg BAROMETRIC PRESSURE.
 3. THE VALUES WRITTEN IN PARENS , (), ARE LIMITED SPEC.
 4. ACOUSTICAL NOISE MEASURING CONDITION:

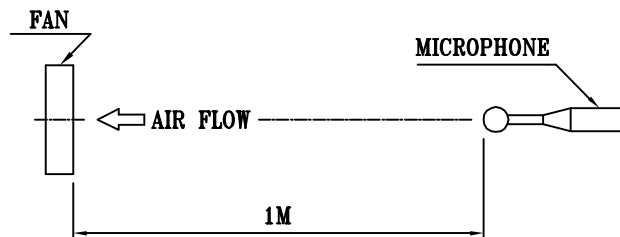

NOISE IS MEASURED AT NOMINAL VOLTAGE IN FREE AIR IN ANECHOIC CHAMBER WITH B & K SOUND LEVEL METER WITH MICROPHONE AT A DISTANCE OF ONE METER FROM THE FAN INTAKE.

PART NO:

DELTA MODEL: GTW020EUB12

3. FEATURES:

DIRECTION OF ROTATION	COUNTERCLOCKWISE, SEEN ON ROTOR
BEARING SYSTEM	BALL BEARINGS
WEIGHT	2.7 K.G. (REF.)
MATERIAL OF ELECTRONICS HOUSING	DIE-CAST ALUMINUM
MATERIAL OF IMPELLER	PLASTIC
ELECTRICAL LEADS	LEAD WIRE
MOTOR PROTECTION	OVER TEMP. PROTECTED
LEAKAGE CURRENT	<= 3.5 mA
INSULATION CLASS	B
TYPE OF PROTECTION	IP54
PROTECTION CLASS	I
POWER FACTOR CORRECTION	ACTIVE
OPERATING TEMPERATURE	-25~+60 °C (REF.)
STORAGE TEMPERATURE	-40~+70 °C (REF.)
EMC	EN61000-6-1 / EN61000-6-3 / EN61000-3-2/3
SAFETY	UL & TUV
LIFE EXPECTANCE	60,000 HOURS CONTINUOUS OPERATION AT 40 °C WITH 15 ~ 65 %RH.
FUNCTIONS	INPUT 0-10VDC/PWM FOR SPEED CONTROL FAN SPEED SIGNAL OUTPUT OUTPUT +12VDC(+/-10%), max. 5mA

PART NO:

DELTA MODEL: GTW020EUB12

4. P & Q CURVE:

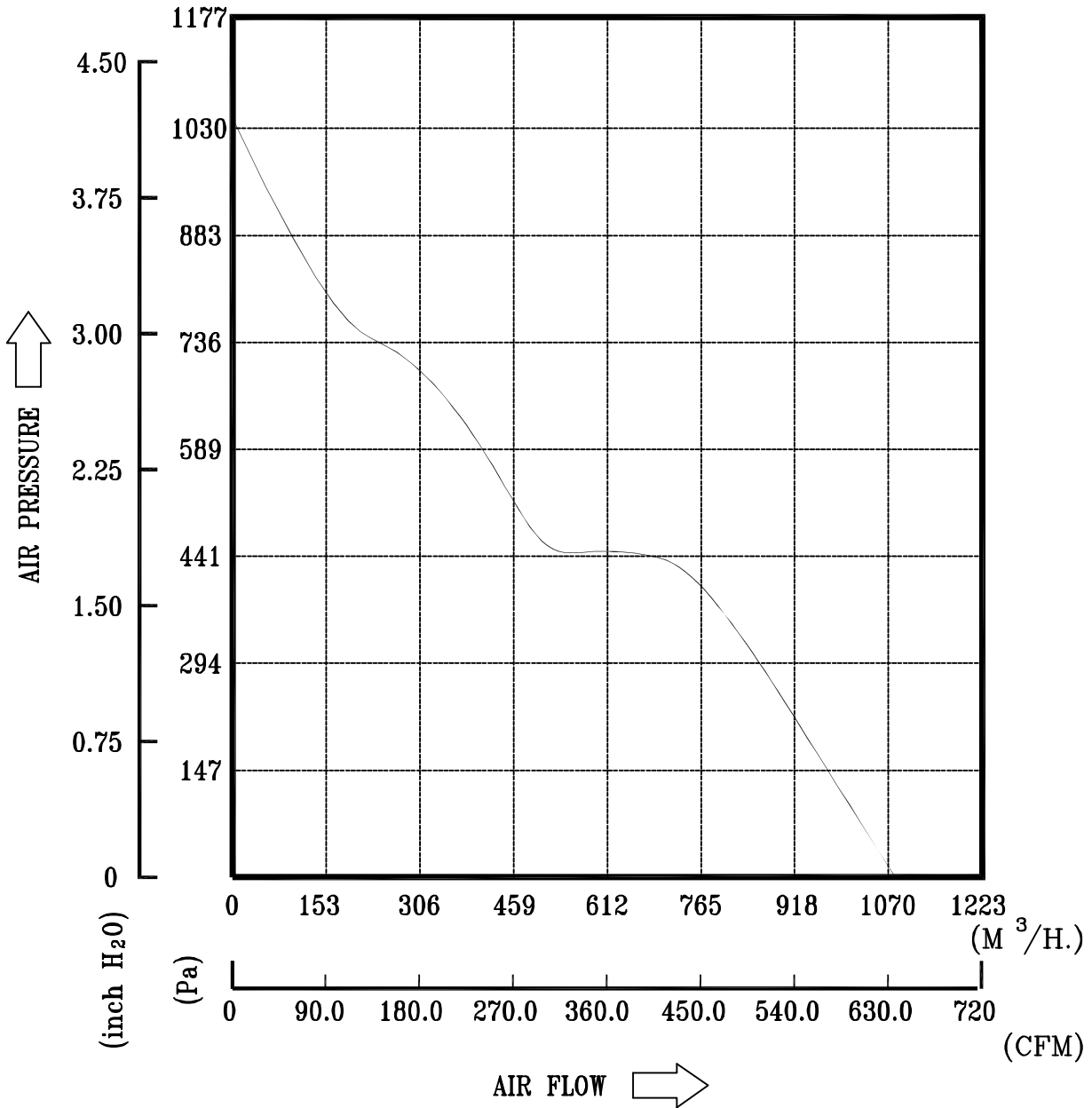

* TEST CONDITION: INPUT VOLTAGE ——— OPERATION VOLTAGE
TEMPERATURE ——— ROOM TEMPERATURE
HUMIDITY ——— 65%RH

PART NO:

DELTA MODEL: GTW020EUB12

5. DIMENSION DRAWING:

LABEL:

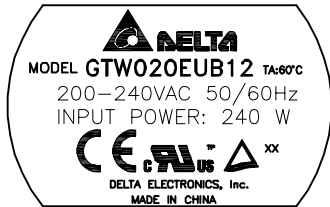

OR

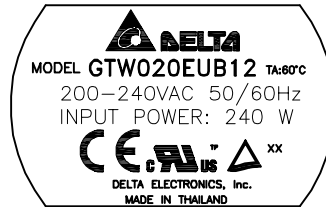

OR

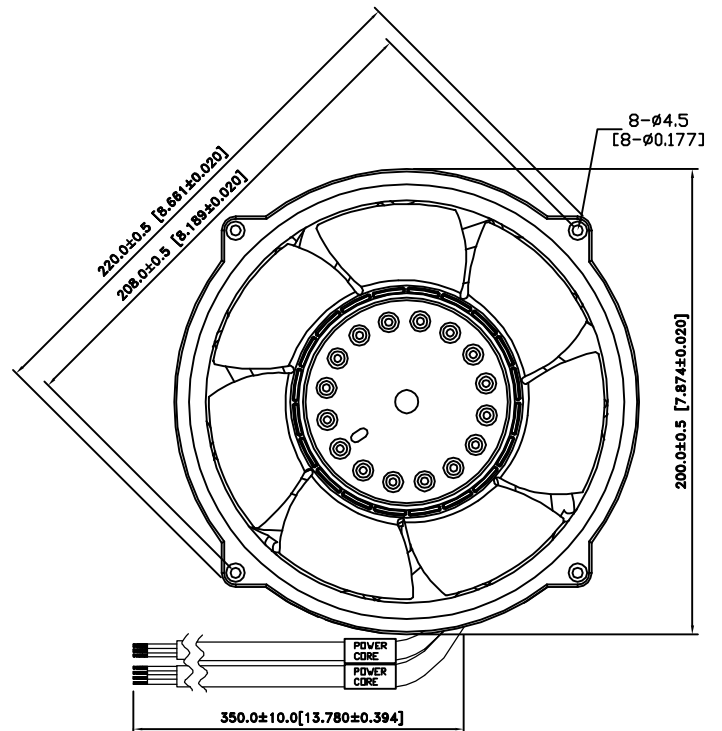
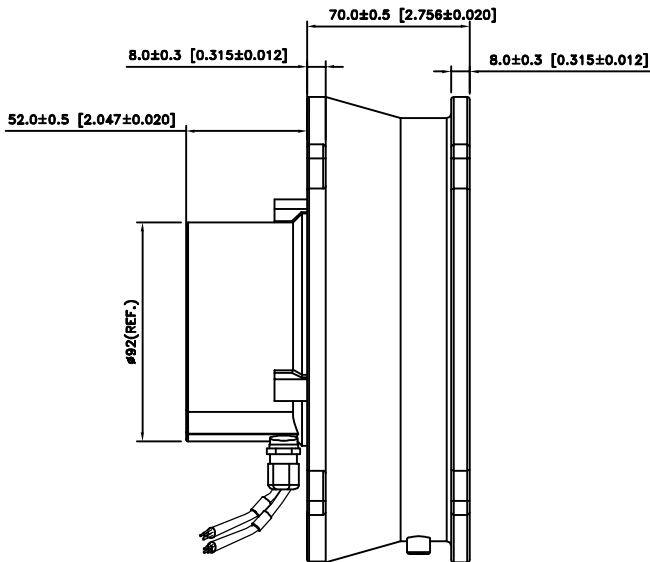
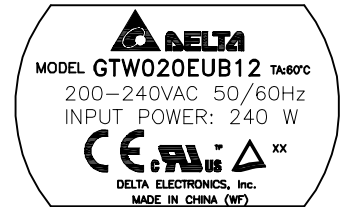

1. LEAD WIRE

BROWN WIRE : L
BLUE WIRE : N
GREEN & YELLOW WIRE : PE

2. LEAD WIRE

RED WIRE : 12VDC OUT
GREEN WIRE : GND
YELLOW WIRE : SPEED CONTROL
(0-10VDC/PWM)
WHITE WIRE : FG O/P

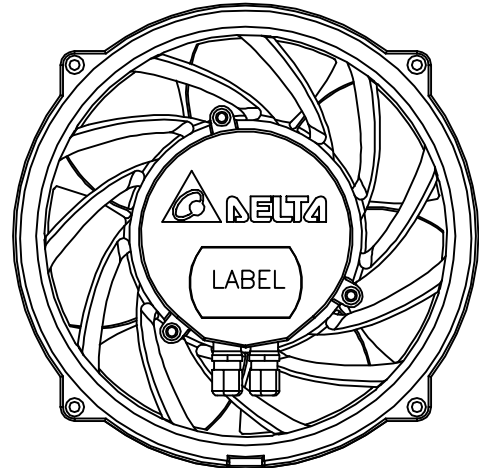

UNIT: mm [INCH]

PART NO:

DELTA MODEL: GTW020EUB12

6. LEAD WIRE CONNECTION:

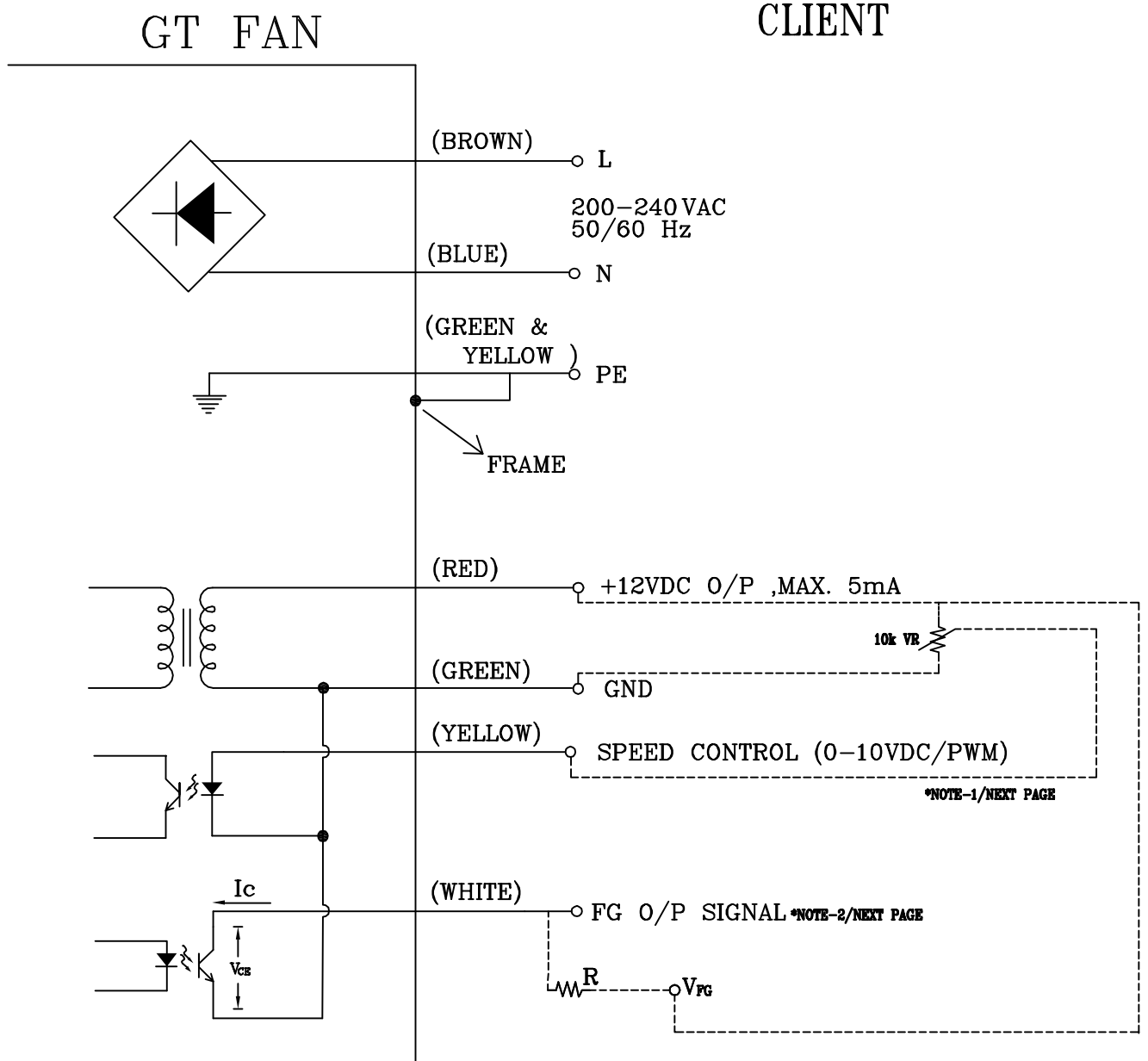

PART NO:

DELTA MODEL: GTW020EUB12

7. FUNCTION CONTROL:

***NOTE-1: SPEED CONTROL SIGNAL**

- THERE ARE TWO WAY TO CONTROL FAN SPEED.

A. VOLTAGE CONTROL

- CONTROL VOLTAGE RANGE SHALL BE 0-10 VDC.
- VOLTAGE AT 10 VDC THE FAN WILL SPIN AT MAXIMUM SPEED.

B. PWM CONTROL

- THE AMPLITUDE VOLTAGE SHALL BE 10VDC. (100Hz~100kHz)

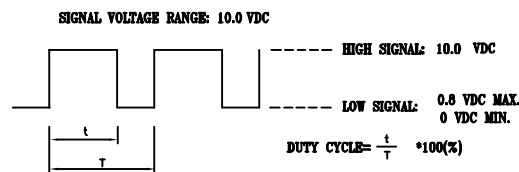

- THE SPEED COMPARISON WITH CONTROL LEVEL:

VOLTAGE(V)	PWM DUTY	SPEED R.P.M. (REF.)	POWER (W)
0.0	0%	800 ± 10%	4.5
5.0	50%	3450 ± 10%	45.0
10.0	100%	6000 ± 10%	149.0

***NOTE-2: FREQUENCY GENERATOR (FG) SIGNAL**

$V_{CE}(\text{sat})=0.7\text{V MAX.}$

$V_{FG}=20.0\text{V MAX.}$

$I_c =5\text{mA MAX.}$

$R \geq V_{FG}/I_c$

FREQUENCY GENERATOR WAVEFORM

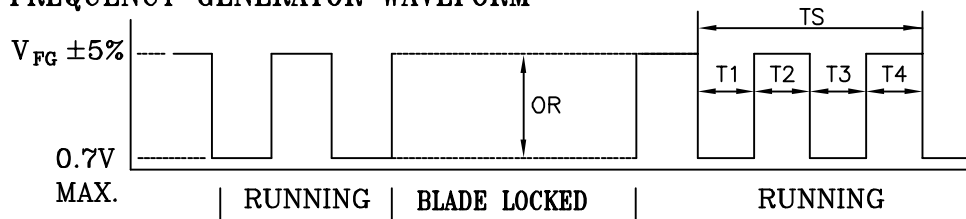

$N=R.P.M$	2 PULSES PER REVOLUTION
$TS=60/N(\text{SEC})$	$T_1=T_2=T_3=T_4=1/4 TS$

Application Notice

1. DELTA WILL NOT GUARANTEE THE PERFORMANCE OF THE PRODUCTS IF THE APPLICATION CONDITION FALLS OUTSIDE THE PARAMETERS SET FORTH IN THE SPECIFICATION.
2. A WRITTEN REQUEST SHOULD BE SUBMITTED TO DELTA PRIOR TO APPROVAL IF DEVIATION FROM THIS SPECIFICATION IS REQUIRED.
3. PLEASE EXERCISE CAUTION WHEN HANDLING FANS. DAMAGE MAY BE CAUSED WHEN PRESSURE IS APPLIED TO THE IMPELLER, IF THE FANS ARE HANDLED BY THE LEAD WIRES, OR IF THE FAN WAS HARD-DROPPED TO THE PRODUCTION FLOOR.
4. EXCEPT AS PERTAINS TO SOME SPECIAL DESIGNS, THERE IS NO GUARANTEE THAT THE PRODUCTS WILL BE FREE FROM ANY SUCH SAFETY PROBLEMS OR FAILURES AS CAUSED BY THE INTRODUCTION OF POWDER, DROPLETS OF WATER OR ENCROACHMENT OF INSECT INTO THE HUB.
5. THE ABOVE-MENTIONED CONDITIONS ARE REPRESENTATIVE OF SOME UNIQUE EXAMPLES AND VIEWED AS THE FIRST POINT OF REFERENCE PRIOR TO ALL OTHER INFORMATION.
6. DELTA FANS WITHOUT SPECIAL PROTECTION ARE NOT SUITABLE WHERE ANY CORROSIVE FLUIDS ARE INTRODUCED TO THEIR ENVIRONMENT.
7. PLEASE ENSURE ALL FANS ARE STORED ACCORDING TO THE STORAGE TEMPERATURE LIMITS SPECIFIED. DO NOT STORE FANS IN A HIGH HUMIDITY ENVIRONMENT. WE HIGHLY RECOMMEND PERFORMANCE TESTING IS CONDUCTED BEFORE SHIPPING, IF THE FANS HAVE BEEN STORED OVER 6 MONTHS.
8. PLEASE BE CAUTIOUS WHEN MOUNTING THE FAN. INCORRECT MOUNTING OF FANS MAY CAUSE EXCESS RESONANCE, VIBRATION AND SUBSEQUENT NOISE.
9. EXCEPT WHERE SPECIFICALLY STATED, ALL TESTS ARE CARRIED OUT AT ROOM (AMBIENT) TEMPERATURE AND RELATIVE HUMIDITY CONDITIONS OF 25^oC, 65% RH. THE TEST VALUE IS ONLY FOR FAN PERFORMANCE ITSELF.
10. THIS AC FAN SHALL COMPLY WITH THE END-PRODUCT STANDARD AFTER INSTALLATION.
11. THIS AC FAN IS DESIGNED IN ORDER TO ASSEMBLE IT WITHIN AN END-USE PRODUCT. DO NOT USE IT INDEPENDENTLY BEFORE INSTALLATION TO AVOID A HAZARD.
12. A FAN GUARD SHALL BE PROVIDED TO AVOID HAZARDS IF THE AC FAN MAY BE ACCESSIBLE BY USERS AFTER INSTALLATION.
13. THE AC FAN SHALL BE SECURE FIXED WITHIN AN END-PRODUCT.
14. DAMAGE TO THE AC FAN AND THE END-PRODUCT MIGHT OCCUR IF INCORRECT INSTALLED.
15. THE METAL FRAME OF THE AC FAN SHALL BE EARTHED AN EARTHING CONDUCTOR SHALL NOT BE LESS THAN 18AWG(0.75mm²).
16. A SPRING OR STAR-WASHER SHALL BE USED TOGETHER WITH EARTHING SCREW FOR CONNECTION .
17. THE AC FAN SHALL BE NOT CONNECTED TO MAINS SUPPLY DURING INSTALLATION.
18. THE AC FAN DISTANCE TO OTHER COMPONENT SHALL BE KEEP 25mm.
19. THE AC FAN SHALL BE USE ONLY THE INCLUDED METAL SCREWS AND NUTS FOR FIXING.
20. THE AC FAN FOR APPLIANCES WITH TYPE Z ATTACHMENT. THE SUPPLY CORD CAN NOT BE REPLACED. IF THE CORD IS DAMAGED THE APPLIANCE SHOULD BE SCRAPPED.
21. THE ROTATING IMPELLER MUST BE GUARDED. AND FAN GUARD SHALL COMPLY WITH THE RELEVANT END-PRODUCT.