

Panasonic

Panasonic

ST1-DC48V-F

Številka dela:

ST1-DC48V-F

Proizvajalec / znamka:

Panasonic

Opis izdelka

RELAY GEN PURPOSE DPST 8A 48V

Podatkovni listi:

 ST1-DC48V-F.pdf

Status RoHS

 Skladen brez svinca / RoHS

Stanje zalog

5601 pcs stock

Iz ladje

Hong Kong

Način pošiljanja

DHL/Fedex/TNT/UPS/EMS

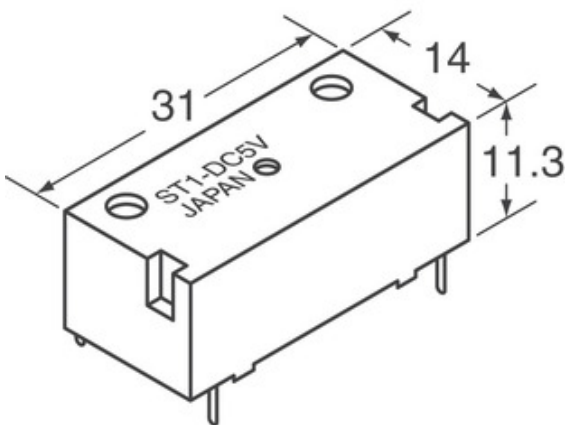

Slika je lahko reprezentativna. Oglejte si specifikacije za podrobnosti izdelka.

[ZAHTEVA ZA PONUDBO](#)











Specifikacije ST1-DC48V-F

ŠTEVILKA DELA	ST1-DC48V-F
PROIZVAJALEC	Panasonic
OPIS	RELAY GEN PURPOSE DPST 8A 48V
STATUS SVOBODNEGA STATUSA / ROHS	Skladen brez svinca / RoHS
KOLIČINA NA VOLJO	5601 pcs
PODATKOVNI LIST	 ST1-DC48V-F.pdf
VKLOPITE NAPETOST (MAKS.)	38.4 VDC
IZKLOP NAPETOSTI (MIN)	4.8 VDC
SKLOP ZAKLJUČKA	PC Pin
PREKLOPNA NAPETOST	380VAC, 250VDC - Max
SERIJA	ST
ČAS IZDAJE	10ms
VRSTA RELEJA	General Purpose
PAKIRANJE	Tube
DRUGA IMENA	255-6226 ST1-DC48V-F-ND
DELOVNA TEMPERATURA	-40°C ~ 60°C
ČAS DELOVANJA	15ms
TIP MONTAŽE	Through Hole
RAVEN OBČUTLJIVOSTI NA VLAGO (MSL)	1 (Unlimited)
STATUS SVOBODNEGA STATUSA / ROHS	Lead free / RoHS Compliant
LASTNOSTI	Sealed - Fully
NATANČEN OPIS	General Purpose Relay DPST-NO/NC (1 Form A, 1 From B) 48VDC Coil Through Hole
OCENA STIKA (TRENUTNA)	8A
KONTAKTNI MATERIAL	Silver Tin Oxide (AgSnO)
KONTAKTNI OBRAZEC	DPST-NO/NC (1 Form A, 1 From B)
NAPETOST TULJAVE	48VDC
VRSTA TULJAVE	Non Latching
ODPORNOST NA KOLUT	9 kOhms
MOČ TULJAVE	240 mW
TOK TEKOČINE	5.3mA

Sorodne oznake

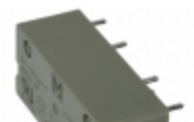
Panasonic ST1-DC48V-F	ST1-DC48V-F Distributer	ST1-DC48V-F Dobavitelj
Cena ST1-DC48V-F	Slike ST1-DC48V-F	Slika ST1-DC48V-F
ST1-DC48V-F PDF Datasheet	ST1-DC48V-F Prenesi podatkovni list	ST1-DC48V-F Datasheet
Zaloga ST1-DC48V-F	Kupi ST1-DC48V-F	Kupi Panasonic ST1-DC48V-F
Panasonic ST1-DC48V-F	Panasonic Dobavitelj	Distributer Panasonic
Panasonic ST1-DC48V-F	Panasonic - Consumer Division ST1-DC48V-F	Panasonic - Consumer Electronics Corp. ST1-DC48V-F
Panasonic Battery Group ST1-DC48V-F	Panasonic Electric Works - ACSD ST1-DC48V-F	Panasonic Electronic Components - Semiconductor Pr ST1-DC48V-F
Panasonic - ATG ST1-DC48V-F	Panasonic - BSG ST1-DC48V-F	Panasonic - DTG ST1-DC48V-F
Panasonic Electric Works ST1-DC48V-F	Panasonic Electronic Components ST1-DC48V-F	Panasonic Industrial Automation Sales ST1-DC48V-F
Panasonic Semiconductor ST1-DC48V-F		

Podobni izdelki

 <p>ST1-DC24V-F Proizvajalci: Panasonic Opis: RELAY GEN PURPOSE DPST 8A 24V Na zalogi: 8546 pcs</p> <p>RFQ</p>	 <p>ST1-DC3V-F Proizvajalci: Panasonic Opis: RELAY GENERAL PURPOSE DPST 8A 3V Na zalogi: 6915 pcs</p> <p>RFQ</p>
 <p>ST1-L2-DC12V Proizvajalci: Panasonic Opis: RELAY GEN PURPOSE DPST 8A 12V Na zalogi: 4110 pcs</p> <p>RFQ</p>	 <p>ST1-DC24V Proizvajalci: Panasonic Opis: RELAY GEN PURPOSE DPST 8A 24V Na zalogi: 4791 pcs</p> <p>RFQ</p>
 <p>ST1-DC48V Proizvajalci: Panasonic Opis: RELAY GEN PURPOSE DPST 8A 48V Na zalogi: 5945 pcs</p> <p>RFQ</p>	 <p>ST1-DC9V Proizvajalci: Panasonic Opis: RELAY GENERAL PURPOSE DPST 8A 9V Na zalogi: 12816 pcs</p> <p>RFQ</p>
 <p>ST1-DC6V Proizvajalci: Panasonic Opis: RELAY GENERAL PURPOSE DPST 8A 6V Na zalogi: 3350 pcs</p> <p>RFQ</p>	 <p>ST1-DC5V Proizvajalci: Panasonic Opis: RELAY GENERAL PURPOSE DPST 8A 5V Na zalogi: 5259 pcs</p> <p>RFQ</p>
 <p>ST1-DC12V-F Proizvajalci: Panasonic Opis: RELAY GEN PURPOSE DPST 8A 12V Na zalogi: 6565 pcs</p> <p>RFQ</p>	 <p>ST1-L2-DC12V-F Proizvajalci: Panasonic Opis: RELAY GEN PURPOSE DPST 8A 12V Na zalogi: 5992 pcs</p> <p>RFQ</p>
 <p>ST1-DC5V-F Proizvajalci: Panasonic Opis: RELAY GENERAL PURPOSE DPST 8A 5V Na zalogi: 8208 pcs</p> <p>RFQ</p>	 <p>ST1-DC15V Proizvajalci: Panasonic Opis: RELAY GEN PURPOSE DPST 8A 15V Na zalogi: 4719 pcs</p> <p>RFQ</p>

