

Panasonic

Panasonic

HJ4-L-DC24V-D-6

Številka dela:

HJ4-L-DC24V-D-6

Proizvajalec / znamka:

Panasonic

Opis izdelka

HJ 4FORM C DC 24V

Podatkovni listi:

Status RoHS

 Skladen brez svineca / RoHS

Stanje zalog

9249 pcs stock

Iz ladje

Hong Kong

Način pošiljanja

DHL/Fedex/TNT/UPS/EMS

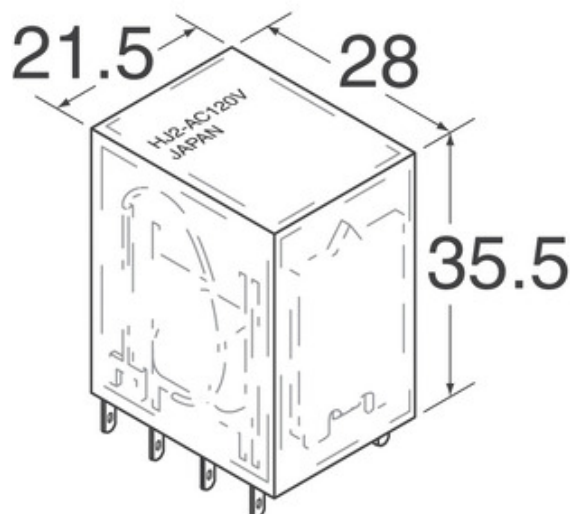

Slika je lahko reprezentativna. Oglejte si specifikacije za podrobnosti izdelka.

[ZAHTEVA ZA PONUDBO](#)













Specifikacije HJ4-L-DC24V-D-6

| | |
|------------------------------------|-----------------------------|
| ŠTEVILKA DELA | HJ4-L-DC24V-D-6 |
| PROIZVAJALEC | Panasonic |
| OPIS | HJ 4FORM C DC 24V |
| STATUS SVOBODNEGA STATUSA / ROHS | Skladen brez svineca / RoHS |
| KOLIČINA NA VOLJO | 9249 pcs |
| PODATKOVNI LIST | |
| SERIJA | * |
| RAVEN OBČUTLJIVOSTI NA VLAGO (MSL) | 1 (Unlimited) |
| STATUS SVOBODNEGA STATUSA / ROHS | Lead free / RoHS Compliant |
| NATANČEN OPIS | Relay Coil |

Sorodne oznake

| | | |
|--|---|--|
| Panasonic HJ4-L-DC24V-D-6 | HJ4-L-DC24V-D-6 Distributer | HJ4-L-DC24V-D-6 Dobavitelj |
| Cena HJ4-L-DC24V-D-6 | Slike HJ4-L-DC24V-D-6 | Slika HJ4-L-DC24V-D-6 |
| HJ4-L-DC24V-D-6 PDF Datasheet | HJ4-L-DC24V-D-6 Prenesi podatkovni list | HJ4-L-DC24V-D-6 Datasheet |
| Zaloga HJ4-L-DC24V-D-6 | Kupi HJ4-L-DC24V-D-6 | Kupi Panasonic HJ4-L-DC24V-D-6 |
| Panasonic HJ4-L-DC24V-D-6 | Panasonic Dobavitelj | Distributer Panasonic |
| Panasonic HJ4-L-DC24V-D-6 | Panasonic - Consumer Division HJ4-L-DC24V-D-6 | Panasonic - Consumer Electronics Corp. HJ4-L-DC24V-D-6 |
| Panasonic Battery Group HJ4-L-DC24V-D-6 | Panasonic Electric Works - ACSD HJ4-L-DC24V-D-6 | Panasonic Electronic Components - Semiconductor Pr HJ4-L-DC24V-D-6 |
| Panasonic - ATG HJ4-L-DC24V-D-6 | Panasonic - BSG HJ4-L-DC24V-D-6 | Panasonic - DTG HJ4-L-DC24V-D-6 |
| Panasonic Electric Works HJ4-L-DC24V-D-6 | Panasonic Electronic Components HJ4-L-DC24V-D-6 | Panasonic Industrial Automation Sales HJ4-L-DC24V-D-6 |
| Panasonic Semiconductor HJ4-L-DC24V-D-6 | | |

Podobni izdelki

| | |
|---|--|
|  <p>HJ4-L-DC48V-6 Proizvajalci: Panasonic Opis: RELAY GENERAL PURPOSE Na zalogi: 6054 pcs</p> <p>RFQ</p> |  <p>HJ4-L-DC12V-6 Proizvajalci: Panasonic Opis: RELAY GENERAL PURPOSE Na zalogi: 5283 pcs</p> <p>RFQ</p> |
|  <p>HJ4-L-DC24V-D Proizvajalci: Panasonic Opis: RELAY GENERAL PURPOSE Na zalogi: 6763 pcs</p> <p>RFQ</p> |  <p>HJ4-L-DC24V Proizvajalci: Panasonic Opis: RELAY GEN PURPOSE 4PDT 5A 24V Na zalogi: 10307 pcs</p> <p>RFQ</p> |
|  <p>HJ4-L-DC48V-D-6 Proizvajalci: Panasonic Opis: RELAY GENERAL PURPOSE Na zalogi: 6998 pcs</p> <p>RFQ</p> |  <p>HJ4-L-DC48V-D Proizvajalci: Panasonic Opis: RELAY GENERAL PURPOSE Na zalogi: 4072 pcs</p> <p>RFQ</p> |
|  <p>HJ4-L-DC48V Proizvajalci: Panasonic Opis: RELAY GEN PURPOSE 4PDT 5A 48V Na zalogi: 11557 pcs</p> <p>RFQ</p> |  <p>HJ4-L-DC12V-D Proizvajalci: Panasonic Opis: RELAY GENERAL PURPOSE Na zalogi: 3044 pcs</p> <p>RFQ</p> |
|  <p>HJ4-L-DC12V-D-6 Proizvajalci: Panasonic Opis: RELAY GENERAL PURPOSE Na zalogi: 3953 pcs</p> <p>RFQ</p> |  <p>HJ4-L-DC24V-6 Proizvajalci: Panasonic Opis: RELAY GENERAL PURPOSE Na zalogi: 3786 pcs</p> <p>RFQ</p> |
|  <p>HJ4-L-T-AC120V Proizvajalci: Panasonic Opis: RELAY GEN PURPOSE 4PDT 5A 120V Na zalogi: 9348 pcs</p> <p>RFQ</p> |  <p>HJ4-L-T-AC100V Proizvajalci: Panasonic Opis: RELAY GEN PURPOSE 4PDT 5A 100V Na zalogi: 8903 pcs</p> <p>RFQ</p> |

Copyright © 2020 Zanesljivo Distributer elektronskih komponent

E-naslov: Info@infinity-electronic.com

Naslov: 17F, komercialna stavba Gaylord, 114-118 cesta Lockhart, Wan Chai, Hong Kong

