



Grayhill, Inc.

## 62S11-L9-020S

Številka dela:

62S11-L9-020S

Proizvajalec / znamka:

Grayhill, Inc.

Opis izdelka

ROTARY ENCODER OPTICAL 32PPR

Podatkovni listi:

 62S11-L9-020S.pdf

Status RoHS

 Skladen brez svinca / RoHS

Stanje zalog

2134 pcs stock

Iz ladje

Hong Kong

Način pošiljanja

DHL/Fedex/TNT/UPS/EMS

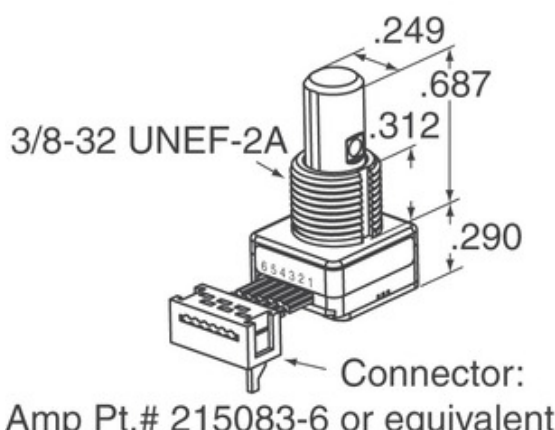

Connector:  
Amp Pt.# 215083-6 or equivalent

Slika je lahko reprezentativna. Oglejte si specifikacije za podrobnosti izdelka.



## Specifikacije 62S11-L9-020S

ŠTEVILKA DELA	62S11-L9-020S
PROIZVAJALEC	Grayhill, Inc.
OPIS	ROTARY ENCODER OPTICAL 32PPR
STATUS SVOBODNEGA STATUSA / ROHS	Skladen brez svinca / RoHS
KOLIČINA NA VOLJO	2134 pcs
PODATKOVNI LIST	 62S11-L9-020S.pdf
NAPETOST - OSKRBA	5V
SKLOP ZAKLJUČKA	Cable Leads
SERIJA	62S
ROTACIJSKO ŽIVLJENJE (CIKLI MIN)	1M
STIKI NA REVOLUCIJO	32
VRSTA IZHODA	Quadrature (Incremental)
DRUGA IMENA	62S11L9020S
USMERJENOST	Vertical
TIP MONTAŽE	Panel Mount
RAVEN OBČUTLJIVOSTI NA VLAGO (MSL)	1 (Unlimited)
STATUS SVOBODNEGA STATUSA / ROHS	Lead free / RoHS Compliant
TIP DAJALNIKA	Optical
PRIDRŽANJE	Yes
VGRAJEN STIKALO	Yes
TIP AKTUATORJA	1/4" Dia Flatted End

## Sorodne oznake

Grayhill, Inc. 62S11-L9-020S	62S11-L9-020S Distributer	62S11-L9-020S Dobavitelj
Cena 62S11-L9-020S	Slike 62S11-L9-020S	Slika 62S11-L9-020S
62S11-L9-020S PDF Datasheet	62S11-L9-020S Prenesi podatkovni list	62S11-L9-020S Datasheet
Zaloga 62S11-L9-020S	Kupi 62S11-L9-020S	Kupi Grayhill, Inc. 62S11-L9-020S
Grayhill, Inc. 62S11-L9-020S	Grayhill, Inc. Dobavitelj	Distributer Grayhill, Inc.
Grayhill, Inc. 62S11-L9-020S	Grayhill Inc. 62S11-L9-020S	

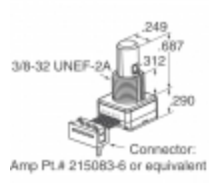
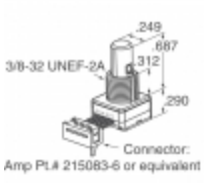
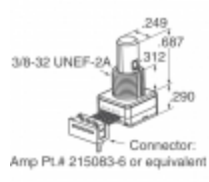
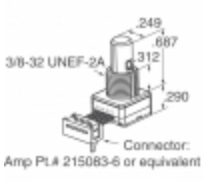
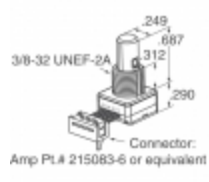
## Podobni izdelki

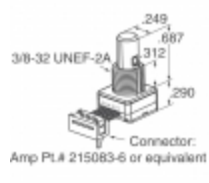
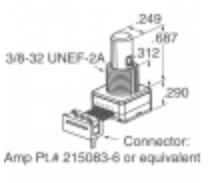
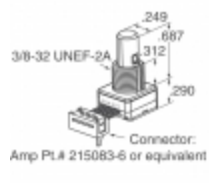
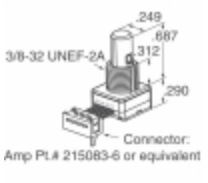
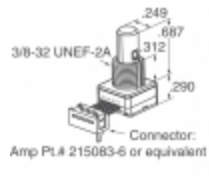
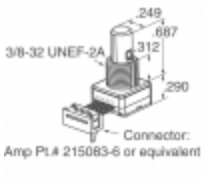
 <p><b>62S11-L9-020SH</b> Proizvajalci: Grayhill, Inc. Opis: ROTARY ENCODER OPTICAL 32PPR Na zalogi: 1952 pcs</p> <p><b>RFQ</b></p>	 <p><b>62S11-L5-060C</b> Proizvajalci: Grayhill, Inc. Opis: ROTARY ENCODER OPTICAL 32PPR Na zalogi: 2163 pcs</p> <p><b>RFQ</b></p>
 <p><b>62S11-M0-020C</b> Proizvajalci: Grayhill, Inc. Opis: ROTARY ENCODER OPT 32PPR 2" CBL Na zalogi: 1812 pcs</p> <p><b>RFQ</b></p>	 <p><b>62S11-L9-PH</b> Proizvajalci: Grayhill, Inc. Opis: ROTARY ENCODER OPTICAL 32PPR Na zalogi: 1972 pcs</p> <p><b>RFQ</b></p>
 <p><b>62S11-M0-030CH</b> Proizvajalci: Grayhill, Inc. Opis: ROTARY ENCODER OPTICAL 32PPR Na zalogi: 2151 pcs</p> <p><b>RFQ</b></p>	 <p><b>62S11-L5-PH</b> Proizvajalci: Grayhill, Inc. Opis: ROTARY ENCODER OPTICAL 32PPR Na zalogi: 2218 pcs</p> <p><b>RFQ</b></p>
 <p><b>62S11-L9-020C</b> Proizvajalci: Grayhill, Inc. Opis: ROTARY ENCODER OPTICAL 32PPR Na zalogi: 1773 pcs</p> <p><b>RFQ</b></p>	 <p><b>62S11-L5-050CH</b> Proizvajalci: Grayhill, Inc. Opis: ROTARY ENCODER OPTICAL 32PPR Na zalogi: 2186 pcs</p> <p><b>RFQ</b></p>
 <p><b>62S11-M0-020SH</b> Proizvajalci: Grayhill, Inc. Opis: ROTARY ENCODER OPT 32PPR 2" CBL Na zalogi: 2051 pcs</p> <p><b>RFQ</b></p>	 <p><b>62S11-L9-020CH</b> Proizvajalci: Grayhill, Inc. Opis: ROTARY ENCODER OPTICAL 32PPR Na zalogi: 2264 pcs</p> <p><b>RFQ</b></p>
 <p><b>62S11-L9-040C</b> Proizvajalci: Grayhill, Inc. Opis: ROTARY ENCODER OPTICAL 32PPR Na zalogi: 1938 pcs</p> <p><b>RFQ</b></p>	 <p><b>62S11-L5-P</b> Proizvajalci: Grayhill, Inc. Opis: ROTARY ENCODER OPTICAL 32PPR Na zalogi: 2265 pcs</p> <p><b>RFQ</b></p>

Copyright © 2020 Zanesljivo Distributer elektronskih komponent

E-naslov: Info@infinity-electronic.com

Naslov: 17F, komercialna stavba Gaylord, 114-118 cesta Lockhart, Wan Chai, Hong Kong

